

KD0475		KD0476																													
	<table border="1"> <tbody> <tr><td>Part No.</td><td>RT-11509C</td></tr> <tr><td>CH part name</td><td>变速箱总成</td></tr> <tr><td>EN part name</td><td>Gear gearbox</td></tr> <tr><td>RU part name</td><td>КПП в сборе</td></tr> <tr><td>Size: mm</td><td>1000*650*600</td></tr> <tr><td>Weight: kg</td><td>320</td></tr> <tr><td>NO.</td><td>NO.23</td></tr> </tbody> </table>	Part No.	RT-11509C	CH part name	变速箱总成	EN part name	Gear gearbox	RU part name	КПП в сборе	Size: mm	1000*650*600	Weight: kg	320	NO.	NO.23		<table border="1"> <tbody> <tr><td>Part No.</td><td>9JS119</td></tr> <tr><td>CH part name</td><td>变速箱总成</td></tr> <tr><td>EN part name</td><td>9 Gear gearbox</td></tr> <tr><td>RU part name</td><td>КПП в сборе</td></tr> <tr><td>Size: mm</td><td>1000*650*600</td></tr> <tr><td>Weight: kg</td><td>300</td></tr> <tr><td>NO.</td><td>NO.23</td></tr> </tbody> </table>	Part No.	9JS119	CH part name	变速箱总成	EN part name	9 Gear gearbox	RU part name	КПП в сборе	Size: mm	1000*650*600	Weight: kg	300	NO.	NO.23
Part No.	RT-11509C																														
CH part name	变速箱总成																														
EN part name	Gear gearbox																														
RU part name	КПП в сборе																														
Size: mm	1000*650*600																														
Weight: kg	320																														
NO.	NO.23																														
Part No.	9JS119																														
CH part name	变速箱总成																														
EN part name	9 Gear gearbox																														
RU part name	КПП в сборе																														
Size: mm	1000*650*600																														
Weight: kg	300																														
NO.	NO.23																														
Remarks: HOWO		Remarks: HOWO 9JS150T																													
KD0477		KD0478																													
	<table border="1"> <tbody> <tr><td>Part No.</td><td>F91409</td></tr> <tr><td>CH part name</td><td>一轴轴承盖</td></tr> <tr><td>EN part name</td><td>Bearing cover</td></tr> <tr><td>RU part name</td><td>К крышка подшипника первичного вала</td></tr> <tr><td>Size: mm</td><td>170*170</td></tr> <tr><td>Weight: kg</td><td>2.05</td></tr> <tr><td>NO.</td><td>NO.23-3</td></tr> </tbody> </table>	Part No.	F91409	CH part name	一轴轴承盖	EN part name	Bearing cover	RU part name	К крышка подшипника первичного вала	Size: mm	170*170	Weight: kg	2.05	NO.	NO.23-3		<table border="1"> <tbody> <tr><td>Part No.</td><td>F91410</td></tr> <tr><td>CH part name</td><td>变速箱前油封</td></tr> <tr><td>EN part name</td><td>Oil seal</td></tr> <tr><td>RU part name</td><td>Сальник переднего вала КПП</td></tr> <tr><td>Size: mm</td><td>47.5*65*6.5</td></tr> <tr><td>Weight: kg</td><td>0.01</td></tr> <tr><td>NO.</td><td>NO.23-6</td></tr> </tbody> </table>	Part No.	F91410	CH part name	变速箱前油封	EN part name	Oil seal	RU part name	Сальник переднего вала КПП	Size: mm	47.5*65*6.5	Weight: kg	0.01	NO.	NO.23-6
Part No.	F91409																														
CH part name	一轴轴承盖																														
EN part name	Bearing cover																														
RU part name	К крышка подшипника первичного вала																														
Size: mm	170*170																														
Weight: kg	2.05																														
NO.	NO.23-3																														
Part No.	F91410																														
CH part name	变速箱前油封																														
EN part name	Oil seal																														
RU part name	Сальник переднего вала КПП																														
Size: mm	47.5*65*6.5																														
Weight: kg	0.01																														
NO.	NO.23-6																														
Remarks: HOWO RT-11509C		Remarks: HOWO RT-11509C 46.6*65*6.35																													

KD0540		
	Part No.	16775
	CH part name	副箱拨叉
	EN part name	Aux fork
	RU part name	вилка
	Size: mm	195*212*55
	Weight: kg	1.4
	NO.	NO.29-3

Remarks: HOWO

KD0542		
	Part No.	16133
	CH part name	一二档拨叉轴
	EN part name	Gear 1 and 2 shifting fork shaft
	RU part name	1 и 2 смены вилку вал
	Size: mm	
	Weight: kg	0.8
	Price: usd	NO.22

Remarks: HOWO 9JS135 11509C 9JS119 9JS150T

Transmission front shell/ Transmission housing	NO.30	HW19710
--	--------------	----------------

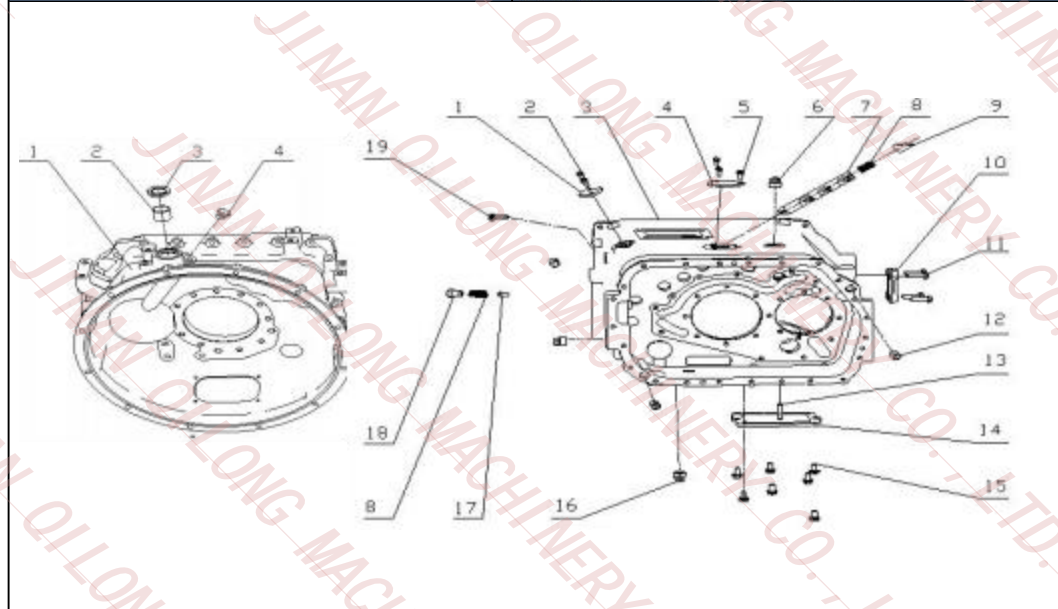

KD0541		
	Part No.	QH70
	CH part name	取力器总成
	EN part name	Power take off
	RU part name	Коробка отбора мощности в сборе
	Size: mm	270*260*150
	Weight: kg	22.5
	NO.	NO.29

Remarks: HOWO

KD0543		
	Part No.	QH50
	CH part name	取力器总成
	EN part name	Power take off
	RU part name	Коробка отбора мощности в сборе
	Size: mm	270*260*150
	Weight: kg	19.5
	NO.	NO.29

Remarks: HOWO

KD0544		
	Part No.	HW19710090601
	CH part name	变速箱总成
	EN part name	Gearbox assy.
	RU part name	Коробка передач в сборе
	Size: mm	600*600*800
	Weight: kg	430
	NO.	NO.30

Remarks: HOWO HW19710 (14.36, 拉式, 双杆) XS180 同步器, HW50-01 取力器

KD0545		
	Part No.	AZ2220000001
	CH part name	变速器前壳(拉式)
	EN part name	Clutch housing
	RU part name	сцепление жилья
	Size: mm	
	Weight: kg	32.1
	NO.	NO.30-1

Remarks: HOWO HW19710 AZ2220000101 (推式)

KD0573		
	Part No.	AZ9003395320
	CH part name	滚针轴承
	EN part name	Needle bearing
	RU part name	игольчатый подшипник
	Size: mm	
	Weight: kg	0.2
	NO.	NO.33-5

Remarks:HOWO HW19710 HW18710

KD0574		
	Part No.	WG2212050002
	CH part name	惰轮轴(右)
	EN part name	Idler shaft (right)
	RU part name	лентяй колеса (справа)
	Size: mm	
	Weight: kg	0.51
	NO.	NO.33-4

Remarks:HOWO HW19710 HW18710

KD0575		
	Part No.	WG2212050001
	CH part name	惰轮轴(左)
	EN part name	Idler wheel (left)
	RU part name	лентяй колеса (слева)
	Size: mm	
	Weight: kg	0.45
	NO.	NO.33-4

Remarks:HOWO HW19710 HW18710

KD0576		
	Part No.	WG2210050001
	CH part name	惰轮
	EN part name	idler pulley
	RU part name	лентяй
	Size: mm	
	Weight: kg	0.85
	NO.	NO.33-3

Remarks:HOWO HW19710 HW18710

Brake assembly **NO.34**

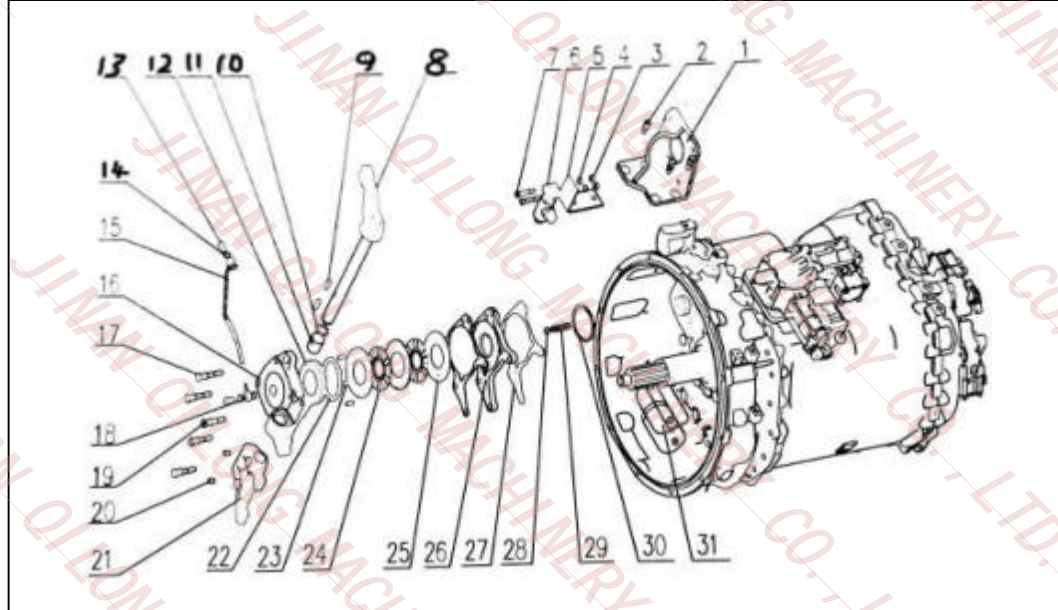

KD0577		
	Part No.	AZ2203060005
	CH part name	端盖总成
	EN part name	End cover assembly
	RU part name	заглушка Ассамблеи
	Size: mm	
	Weight: kg	0.65
	NO.	NO.34-26

Remarks:HOWO HW19710 HW18710

KD0578		
	Part No.	WG2229060010
	CH part name	变速器制动片
	EN part name	Transmission brake pad
	RU part name	трансмиссия тормозной лист
	Size: mm	
	Weight: kg	0.3
	NO.	NO.34-24

Remarks:HOWO HW19710 HW18710

	Part No. CH part name EN part name RU part name Size: mm Weight: kg NO.	AZ2203030001 副轴总成 (左) Countershaft assembly (left) вторичного вала Ассамблеи (слева) 20.5 NO.32		Part No. CH part name EN part name RU part name Size: mm Weight: kg NO.	AZ2203030005 AMT副轴总成 (右) Countershaft assembly (right) вторичного вала Ассамблеи (справа) 20.5 NO.32	
Remarks:HOWO HW19710			Remarks:HOWO HW19710			
	Part No. CH part name EN part name RU part name Size: mm Weight: kg Price: usd	AZ9003329309 圆柱滚子轴承 Cylindrical roller bearing Цилиндрические роликовые подшипники 0.62 NO.32-15-27		Part No. CH part name EN part name RU part name Size: mm Weight: kg Price: usd	WG2203040009 主轴带球头总成 Spindle head assembly глава ассамблеи 6.8 NO.32-15	
Remarks:HOWO HW19710			Remarks:HOWO HW19710 10 side double key			
Idler wheel NO.33						
			Part No. CH part name EN part name RU part name Size: mm Weight: kg NO.			AZ2210030215 副轴 (右) Countershaft вторичного вала 8.5 NO.32-5
Remarks:HOWO HW19710			Remarks:HOWO HW19710 HW18710			
	Part No. CH part name EN part name RU part name Size: mm Weight: kg NO.	WG2229050001 垫片 Shim прокладка 0.03 NO.33-6		Part No. CH part name EN part name RU part name Size: mm Weight: kg NO.	AZ2210030220 副轴 (左) Countershaft вторичного вала 8.5 NO.32-5	
Remarks:HOWO HW19710			Remarks:HOWO HW19710 HW18710			

	Part No.	WG2229003030		Part No.	AZ9003073001
	CH part name	复合衬套		CH part name	骨架油封
	EN part name	Composite bush		EN part name	Skeleton oil seal
	RU part name	втулка		RU part name	скелет нефти печать
	Size: mm	300*340*300		Size: mm	300*450*80
	Weight: kg	0.03		Weight: kg	0.06
	NO.	NO.30-2		NO.	NO.30-3
Remarks:HOWO HW19710			Remarks:HOWO HW19710		
	Part No.	AZ2220010003		Part No.	WG2229010002
	CH part name	AMT变速器中壳		CH part name	螺塞
	EN part name	Housing gear box		EN part name	Square nead plug
	RU part name	жилищные коробки передач		RU part name	площадь nead пробка
	Size: mm			Size: mm	
	Weight: kg	135		Weight: kg	0.13
	NO.	NO.30-3		NO.	NO.30-6
Remarks:HOWO HW19710 AZ2203010101 9档			Remarks:HOWO HW19710		
	Part No.	WG2203010002		Part No.	WG2229010001
	CH part name	放油螺塞总成		CH part name	定位销
	EN part name	Square nead plug		EN part name	Dowel
	RU part name	площадь nead пробка		RU part name	шканд
	Size: mm			Size: mm	
	Weight: kg	0.2		Weight: kg	0.01
	NO.	NO.30-16		NO.	NO.30-12
Remarks:HOWO HW19710			Remarks:HOWO HW19710		
	Part No.	WG2229020005		Part No.	AZ2210020111
	CH part name	衬套		CH part name	输入轴
	EN part name	bushing		EN part name	Input shaft
	RU part name	втулка		RU part name	входной вал
	Size: mm			Size: mm	
	Weight: kg	0.7		Weight: kg	5.3
	NO.	NO.31-5		NO.	NO.31-3
Remarks:HOWO HW19710			Remarks:HOWO HW19710		

	Part No. CH part name EN part name RU part name Size: mm Weight: kg NO.	F99588 1/2和5/6档导块 1/2、 5/6Gear guide block 1 / 2 、 5 / 6gear руководства блока 55*48*35 0.19 NO.29-17		Part No. CH part name EN part name RU part name Size: mm Weight: kg NO.	F96085/F96084 压缩弹簧 Compression spring сжатие весной 0.01 NO.29-8
Remarks:HOWO 9JS135 11509C 9JS119			Remarks:HOWO 9JS135 11509C 9JS119		
	Part No. CH part name EN part name RU part name Size: mm Weight: kg NO.	F99589 3/4和7/8档导块 3/4、 7/8Gear guide block 3/4 и 7/8 файл руководства блока 78*65*55 0.44 NO.29-23		Part No. CH part name EN part name RU part name Size: mm Weight: kg NO.	F99664 低倒档拨叉 Shift yoke низкий реверсивный вилка 185*100*65 0.86 NO.29-15
Remarks:HOWO 9JS135 11509C 9JS119 9JS150T			Remarks:HOWO 9JS135 11509C 9JS119 9JS150T		
	Part No. CH part name EN part name RU part name Size: mm Weight: kg NO.	A-C09016 换挡气缸总成 Shift cylinder П пневмоцилиндр переключения передач в сборе 240*145*140 6.49 NO.29		Part No. CH part name EN part name RU part name Size: mm Weight: kg NO.	JS100A-1702055 1/2档拨叉 3/4 gear dial fork В илка переключения 3- й и 4- й передач 200*175*83 1.34 NO.29-19
Remarks:HOWO 9JS135 11509C 9JS119 9JS150T			Remarks: HOWO		
	Part No. CH part name EN part name RU part name Size: mm Weight: kg NO.	750132019 换挡气缸 Shift cylinder П пневмоцилиндр переключения передач в сборе 1.23 NO.29		Part No. CH part name EN part name RU part name Size: mm Weight: kg NO.	JS100A-1702056 3/4档拨叉 3/4 gear dial fork В илка переключения 3- й и 4- й передач 200*175*83 1.34 NO.29-21
Remarks: HOWO			Remarks: HOWO		

Input shaft and end cover assembly		NO.31		
		KD0554		
		Part No.	AZ2210020112	
		CH part name	传动主动齿轮 (低)	
		EN part name	Driving drive gear (low)	
		RU part name	дальнего лова (низкий)	
Size: mm				
Weight: kg	3.5			
NO.	NO.31-8			
Remarks:HOWO HW19710				
		KD0555		
		Part No.	WG2210020003	
		CH part name	插分档同步器锥毂	
		EN part name	Synchronizer hub	
		RU part name	конус узла	
Size: mm				
Weight: kg	2.9			
NO.	NO.31-12			
Remarks:HOWO HW19710				
KD0556		KD0557		
	Part No.	WG2210020004	Part No.	WG2229020001
	CH part name	插分档同步器同步环	CH part name	同步推块
	EN part name	Synchronizer ring	EN part name	Pressure piece
	RU part name	Кольцо синхронизации	RU part name	Упорный сухарь синхронизации
	Size: mm		Size: mm	
	Weight: kg	0.33	Weight: kg	0.02
NO.	NO.31-16	NO.	NO.31-19	
Remarks:HOWO HW19710		Remarks:HOWO HW19710		
KD0558		KD0559		
	Part No.	WG2210020005	Part No.	WG2229020002
	CH part name	插分档同步滑套	CH part name	推块外弹簧
	EN part name	Synchronous slip sleeve	EN part name	Push block outer spring
	RU part name	синхронный Slip рукав	RU part name	толкать блок внешняя пружина
	Size: mm		Size: mm	
	Weight: kg	1.98	Weight: kg	0.01
NO.	NO.31-25	NO.	NO.31-21	
Remarks:HOWO HW19710		Remarks:HOWO HW19710		

	Part No. CH part name EN part name RU part name Size: mm Weight: kg NO.	AZ2220100005 变速器后壳 Transmission rear housing после передачи корпуса 19 NO.35-58		Part No. CH part name EN part name RU part name Size: mm Weight: kg NO.	AZ2203100030 AMT范围档副箱总成 AMT range file sub box assembly диапазон файл к коробке ассамблеи амт 90.6 NO.35
Remarks:HOWO HW19710 HW20716			Remarks:HOWO HW19710 HW18710 9 files, 10 files, pull type AZ2203100042		
	Part No. CH part name EN part name RU part name Size: mm Weight: kg NO.	AZ2225100001 输出轴 output shaft выходной вал 2.98 NO.35-12		Part No. CH part name EN part name RU part name Size: mm Weight: kg NO.	AZ2203100005 低档锥毂总成 Low grade cone hub assembly слабый конус узла 2.1 NO.35-27
Remarks:HOWO HW19710 HW18710			Remarks:HOWO HW19710 HW18710		
	Part No. CH part name EN part name RU part name Size: mm Weight: kg NO.	AZ9003326322 滚动轴承 Cylindrical roller bearing Цилиндрические роликовые подшипники NO.35-14		Part No. CH part name EN part name RU part name Size: mm Weight: kg NO.	WG2210100005 内齿圈 Inner ring gear внутренняя передача кольцо 4 NO.35-15
Remarks:HOWO HW19710 HW18710 63/22 GB/T276 AZ9003991056			Remarks:HOWO HW19710 HW18710		
	Part No. CH part name EN part name RU part name Size: mm Weight: kg NO.	WG2229020003 推块内弹簧 Push block spring внутренняя пружина толкает блок 0.01 NO.35-67		Part No. CH part name EN part name RU part name Size: mm Weight: kg NO.	WG2210100006 齿圈支架 Gear ring bracket зуб кольцо скобка 250*80 0.6 NO.35-16
Remarks:HOWO HW19710 HW18710			Remarks:HOWO HW19710 HW18710		

KD0560		
	Part No.	AZ9003326213
	CH part name	轴承
	EN part name	Bearing
	RU part name	Роликоподшипник
	Size: mm	120*23
	Weight: kg	1
	NO.	NO.31-23

Remarks:HOWO HW19710 6213N-GB/T276

KD0561		
	Part No.	AZ2208020001
	CH part name	卡簧
	EN part name	Stop ring
	RU part name	прекрати кольцо
	Size: mm	
	Weight: kg	0.01
	NO.	NO.31-29

Remarks:HOWO HW19710

KD0562		
	Part No.	AZ9003070055
	CH part name	骨架油封
	EN part name	Skeleton oil seal
	RU part name	скелет нефти печать
	Size: mm	550*750*120
	Weight: kg	0.03
	NO.	NO.31-41

Remarks:HOWO HW19710

KD0563		
	Part No.	WG2222020001
	CH part name	输入轴端盖
	EN part name	Cover
	RU part name	К крышка подшипника первичного вала
	Size: mm	
	Weight: kg	2.3
	NO.	NO.31-38

Remarks:HOWO HW19710

KD0564		
	Part No.	WG2229020007
	CH part name	导油环
	EN part name	Oil guide ring
	RU part name	нефть руководства кольцо
	Size: mm	250x80
	Weight: kg	0.4
	NO.	NO.31-42

Remarks:HOWO HW19710

Countershaft/ principal axis **NO.32**

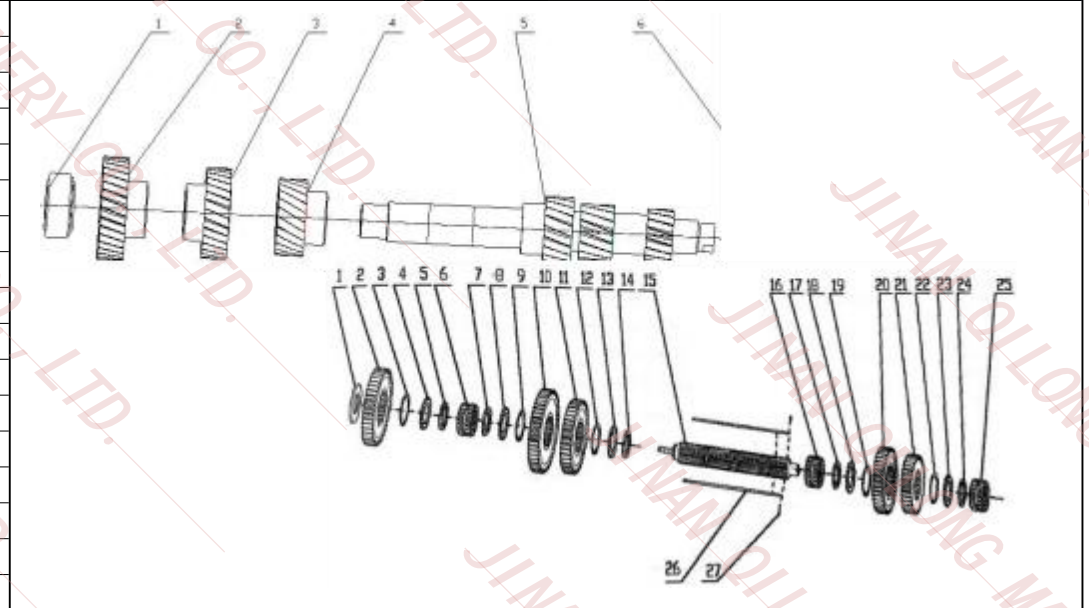

KD0565		
	Part No.	AZ2203040001
	CH part name	主轴总成
	EN part name	Spindle assembly
	RU part name	основной вал в сборе
	Size: mm	
	Weight: kg	32
	NO.	NO.32

Remarks:HOWO HW19710

KD0579		
	Part No.	AZ2229260025
	CH part name	变速器制动支架
	EN part name	Transmission brake bracket
	RU part name	трансмиссия тормозной скобка
	Size: mm	
	Weight: kg	1.5
	NO.	NO.34-16

Remarks:HOWO HW19710 HW18710

KD0580		
	Part No.	AZ2214260001
	CH part name	离合器分离拨叉
	EN part name	Clutch release fork
	RU part name	сцепление вилка
	Size: mm	
	Weight: kg	0.61
	NO.	NO.34-20

Remarks:HOWO HW19710 HW18710

KD0581		
	Part No.	AZ2229260015
	CH part name	助力缸支架(拉式)
	EN part name	The power cylinder bracket (pull)
	RU part name	власть цилиндра скобки
	Size: mm	2300*7500
	Weight: kg	0.53
	NO.	NO.34-1

Remarks:HOWO HW19710 HW18710

KD0582		
	Part No.	AZ2203260002
	CH part name	拨叉轴总成
	EN part name	Fork shaft assembly
	RU part name	вилка вал в сборе
	Size: mm	
	Weight: kg	1.2
	NO.	NO.34-8

Remarks:HOWO HW19710 HW18710 9 files, 10 files, pull type

KD0583		
	Part No.	WG2229270004
	CH part name	软轴支架 (拉式)
	EN part name	Flexible shaft support (pull type)
	RU part name	гибкого стержня поддержки (Pull типа).
	Size: mm	
	Weight: kg	0.21
	NO.	NO.34

Remarks:HOWO HW19710 HW18710

Range file box **NO.35**

KD0584		
	Part No.	AZ9003326020
	CH part name	滚动轴承
	EN part name	Rolling bearing
	RU part name	скользящий подшипник
	Size: mm	120*23
	Weight: kg	1
	NO.	NO.35-1

Remarks:HOWO HW19710 HW18710 6020 GB/T276

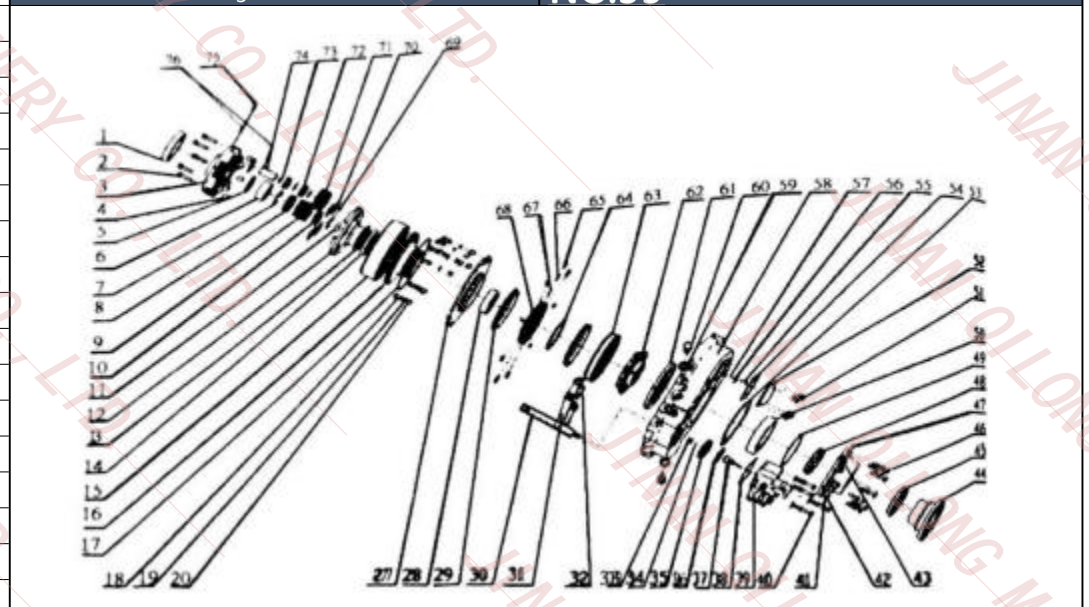

KD0601		
	Part No.	WG2229100043
	CH part name	拨叉支撑销
	EN part name	Shifting fork support pin
	RU part name	вилка поддержки пин
	Size: mm	
	Weight: kg	0.25
Price: usd	NO.35-60	

Remarks:HOWO HW19710 HW18710

KD0603		
	Part No.	WG2214100002
	CH part name	范围档拨叉轴
	EN part name	Range shift fork shaft
	RU part name	диапазон файл вал вилка
	Size: mm	
	Weight: kg	1.05
Price: usd	NO.35-30	

Remarks:HOWO HW19710 HW18710 WG2212230001

10 gear small cover and pull fork assembly **NO.36**

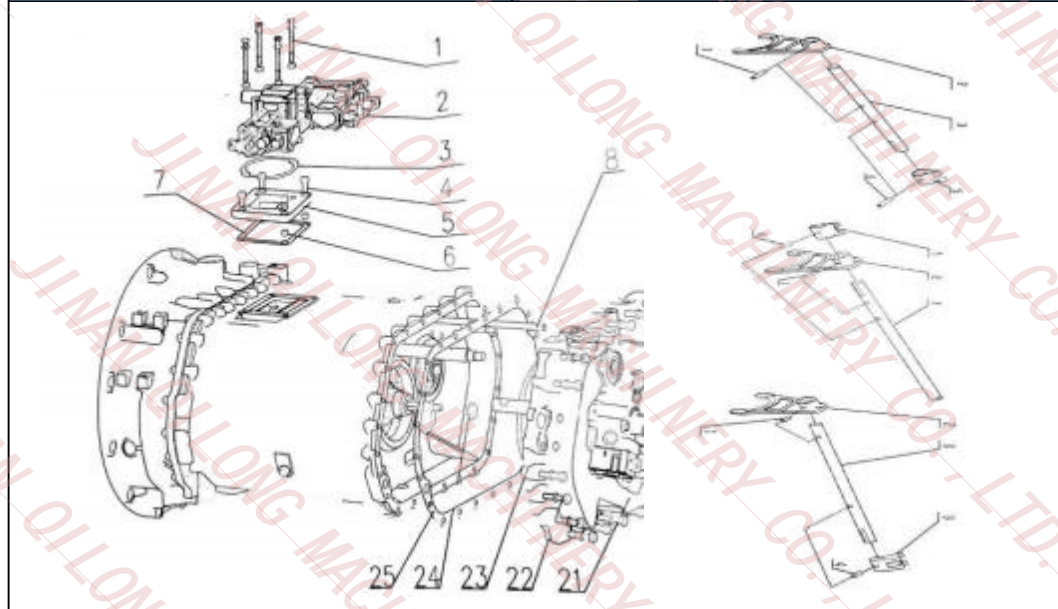

KD0602		
	Part No.	WG2229100042
	CH part name	拨叉摆块
	EN part name	Shifting fork
	RU part name	вилка маятник блок
	Size: mm	
	Weight: kg	0.14
Price: usd	NO.35-32	

Remarks:HOWO HW19710 HW18710

KD0604		
	Part No.	WG2229100050
	CH part name	范围档活塞
	EN part name	Range stop piston
	RU part name	диапазон сохранения поршень
	Size: mm	
	Weight: kg	0.11
Price: usd	NO.35-35	

Remarks:HOWO HW19710 HW18710

KD0605		
	Part No.	WG2209100005
	CH part name	AMT范围挡气缸总成
	EN part name	Range block cylinder
	RU part name	диапазон сохранения цилиндр
	Size: mm	
	Weight: kg	0.3
Price: usd	NO.35-39	

Remarks:HOWO HW19710 HW18710 WG2209230005

KD0606		
	Part No.	WG2209210001
	CH part name	执行机构
	EN part name	Small cap assembly
	RU part name	небольшой покрытия Ассамблеи
	Size: mm	
	Weight: kg	2.1
Price: usd	NO.36-2	

Remarks:HOWO HW19710 HW18710

	Part No. CH part name EN part name RU part name Size: mm Weight: kg NO.	WG2210100008 范围档同步滑套 Synchronous slip sleeve синхронный скользящей муфты 1.99 NO.35-63		Part No. CH part name EN part name RU part name Size: mm Weight: kg NO.	AZ2229100029 范围档锁止块 Locking block замок блок 0.32 NO.35
Remarks:HOWO HW19710 HW18710			Remarks:HOWO HW19710 HW18710		
	Part No. CH part name EN part name RU part name Size: mm Weight: kg NO.	WG2203100006 高档锥毂总成 High grade cone boss полноценный конус узла 3.04 NO.35-62		Part No. CH part name EN part name RU part name Size: mm Weight: kg NO.	WG2222100004 输出轴后端盖 Output shaft rear end cover выходной вал задней крышки 210*210 2.9 NO.35-47
Remarks:HOWO HW19710 HW18710			Remarks:HOWO HW19710 HW18710		
	Part No. CH part name EN part name RU part name Size: mm Weight: kg NO.	AZ9003070105 骨架油封 Skeleton oil seal скелет нефти печать 105*130*14 0.06 NO.35-45		Part No. CH part name EN part name RU part name Size: mm Weight: kg NO.	WG2229100041 输出轴后端盖纸垫 Output shaft back cover paper pad выходной вал задней крышке колодка 120*120*0.1 0.002 NO.35-53
Remarks:HOWO HW19710 HW18710			Remarks:HOWO HW19710 HW18710		
	Part No. CH part name EN part name RU part name Size: mm Weight: kg NO.	WG2214100001 范围档拨叉 Range shift fork диапазон смены - форк 250*80 NO.35-31		Part No. CH part name EN part name RU part name Size: mm Weight: kg NO.	WG2210100018 输出法兰盘 Output flange выходной фланец 180*180*90 NO.35-44
Remarks:HOWO HW19710 HW18710 WG2214230001			Remarks:HOWO HW19710 HW18710		

	Part No. AZ2203240008 CH part name 副箱进油管总成 EN part name Sub tank inlet pipe RU part name входной трубы заместитель коробка Size: mm 150*20*15 Weight: kg 0.25 Price: usd NO.37-16		Part No. WG9100710069 CH part name 压力开关 EN part name Pressure switch RU part name переключатель давления Size: mm Weight: kg 0.05 Price: usd NO.37-34
Remarks:HOWO HW19710		Remarks:HOWO HW19710	
	Part No. WG2209280010 CH part name 里程表传感器 EN part name Odometer Sensor RU part name датчик спидометра Size: mm 90*40*40 Weight: kg 0.1 Price: usd NO.37-8		Part No. AZ2203250003 CH part name 双H阀总成 EN part name Double H valve assembly RU part name двойной h клапан в сборе Size: mm Weight: kg 0.2 Price: usd NO.37
Remarks:HOWO HW19710 HW18710		Remarks:HOWO HW19710 HW18710 WG2203250003	
Gearbox accessories		NO.37	
			
Remarks:HOWO HW19710 HW18710		Remarks:HOWO HW19710 HW18710	
	Part No. WG2209280005 CH part name 输入轴速度传感器 (AMT) EN part name Input shaft speed sensor RU part name входной вал датчик скорости Size: mm 380*220*80 Weight: kg 0.21 Price: usd NO.37-2		Part No. WG2209280006 CH part name 输出轴速度传感器(AMT) EN part name Output shaft speed sensor RU part name выходной вал датчик скорости Size: mm 130*100*20 Weight: kg 0.21 NO. NO.37-3
Remarks:HOWO HW19710 HW18710		Remarks:HOWO HW19710 HW18710	

	Part No.	VG1557090015
	CH part name	EGR控制气缸电磁阀
	EN part name	Solenoid valve
	RU part name	электромагнитный клапан
	Size: mm	
	Weight: kg	0.35
	NO.	NO.37-10

Remarks:HOWO HW19710 HW18710

	Part No.	WG2229100062
	CH part name	副箱纸垫
	EN part name	Paper pad
	RU part name	бумажная прокладка
	Size: mm	
	Weight: kg	0.05
	NO.	NO.37-42

Remarks:HOWO HW19710 HW18710

	Part No.	AZ2203210040+001
	CH part name	10档小盖总成
	EN part name	Double H device assy
	RU part name	двойная h устройство, астрид
	Size: mm	
	Weight: kg	10.8
	NO.	NO.37-2

Remarks:HOWO HW19710 HW18710

	Part No.	WG2229210040
	CH part name	选档杆总成
	EN part name	Selector lever assembly
	RU part name	рычаг в сборе
	Size: mm	
	Weight: kg	0.5
	NO.	NO.37

Remarks:HOWO HW19710 HW18710

GEARBOX GEAR CHANGE SYSTEM **NO.38**

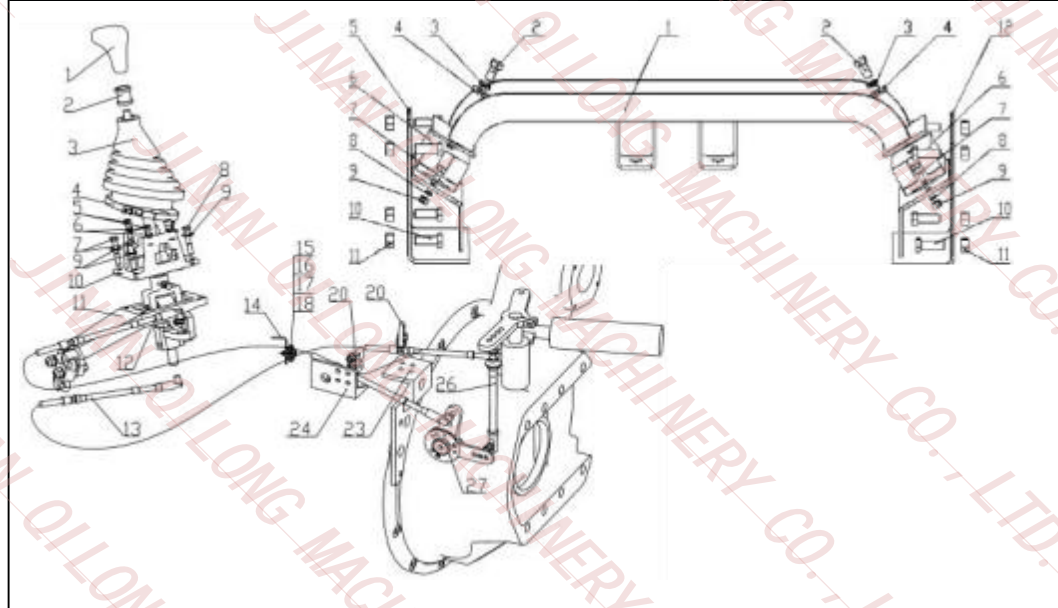



	Part No.	WG9716240010
	CH part name	操纵器总成
	EN part name	Operator assembly
	RU part name	оператор ассамблеи
	Size: mm	
	Weight: kg	5.1
	NO.	NO.38

Remarks: HOWO

	Part No.	AZ9100240061
	CH part name	换挡手柄9档
	EN part name	Gear shift knob
	RU part name	ручки переключения скоростей
	Size: mm	
	Weight: kg	0.15
	NO.	NO.38-1

Remarks:HOWO AZ9716240001

	Part No. CH part name EN part name RU part name Size: mm Weight: kg NO.	F99660 双H气阀 Double H valve двойная H клапан 118*47*38 0.29 NO.24-22		Part No. CH part name EN part name RU part name Size: mm Weight: kg NO.	KD0494 55522/55523/55518 气管总成 Air pipe Воздушная трубка 770*15 0.78 NO.24-29-30-31
Remarks: HOWO			Remarks: HOWO		
	Part No. CH part name EN part name RU part name Size: mm Weight: kg NO.	KD0495 79100710069 高低档开关 High- low gear switch Переключатель низшей и высшей передач 51*27 0.04 NO.24		Part No. CH part name EN part name RU part name Size: mm Weight: kg NO.	KD0496 79100710068 倒挡开关 Reverse gear switch В ыключатель задней передачи 51*29 0.04 NO.24-45
Remarks: HOWO			Remarks: HOWO		
	Part No. CH part name EN part name RU part name Size: mm Weight: kg NO.	KD0497 99012710041 空挡开关 Neutral switch В ыключатель нейтрального положения 53*22 0.08 NO.24-41		Part No. CH part name EN part name RU part name Size: mm Weight: kg NO.	KD0498 15276 通气塞 Air vent plug вытяжка пробка 0.15 NO.24-37
Remarks: HOWO			Remarks: HOWO		
	Part No. CH part name EN part name RU part name Size: mm Weight: kg NO.	KD0499 19726 副箱主轴减速齿 Release gear Понижающая шестерня главного вала 225*102*38 5.01 NO.25-5		Part No. CH part name EN part name RU part name Size: mm Weight: kg NO.	KD0500 18869 副箱驱动齿轮 Drive gear Шестерня привода делителя передач 144*86*67 2.55 NO.25-8
Remarks:HOWO 9JS135 11509C			Remarks:HOWO 9JS135 11509C		

	Part No. CH part name EN part name RU part name Size: mm Weight: kg Price: usd	AZ2229210038 执行机构转接板 Mechanism connecting plate механизм подключения Совета 1.01 NO.36-5		Part No. CH part name EN part name RU part name Size: mm Weight: kg Price: usd	AZ2229210045 执行机构转接板纸垫 Paper pad бумажная прокладка 0.001 NO.36-3
Remarks:HOWO HW19710 HW18710			Remarks:HOWO HW19710 HW18710		
	Part No. CH part name EN part name RU part name Size: mm Weight: kg NO.	WG2212220001 倒档拨叉轴 Reverse shift fork shaft реверсивный вал вилка 0.52 NO.36-8		Part No. CH part name EN part name RU part name Size: mm Weight: kg NO.	WG2214220001 拨叉 Shift fork вилка 0.65 NO.36-2
Remarks:HOWO HW19710 HW18710			Remarks:HOWO HW19710 HW18710		
	Part No. CH part name EN part name RU part name Size: mm Weight: kg NO.	WG2214220012 倒挡拨块 Dial block номер блока 0.25 NO.36-9		Part No. CH part name EN part name RU part name Size: mm Weight: kg NO.	WG2214220013 前进档拨块 Forward stop block В перед разнохивает блоков 0.23 NO.36-5-6
Remarks:HOWO HW19710 HW18710 AZ2214220012			Remarks:HOWO HW19710 HW18710 AZ2214220013		
	Part No. CH part name EN part name RU part name Size: mm Weight: kg Price: usd	WG2203250018 成型软管 Molding hose шланг 380*220*80 0.16 NO.37-5		Part No. CH part name EN part name RU part name Size: mm Weight: kg Price: usd	WG2203250019 成型软管 Molding hose шланг 300*260*120 0.15 NO.37-6
Remarks:HOWO HW19710 HW18710			Remarks:HOWO HW19710 HW18710		

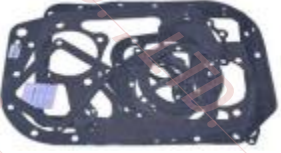
KD0487		
	Part No.	20822
	CH part name	FL变速箱维修
	EN part name	FL gearbox repair kit
	RU part name	Ремкомплект коробки передач FL
	Size: mm	450*360*6
	Weight: kg	0.2
	NO.	NO.23

Remarks: HOWO

KD0489		
	Part No.	F96194
	CH part name	双H壳体
	EN part name	Double H housing
	RU part name	Корпус двойного H-образного клапана
	Size: mm	360*180*75
	Weight: kg	6.24
	NO.	NO.24-1

Remarks:RT-11509C F96194-6

SWITCH GEAR NO.24

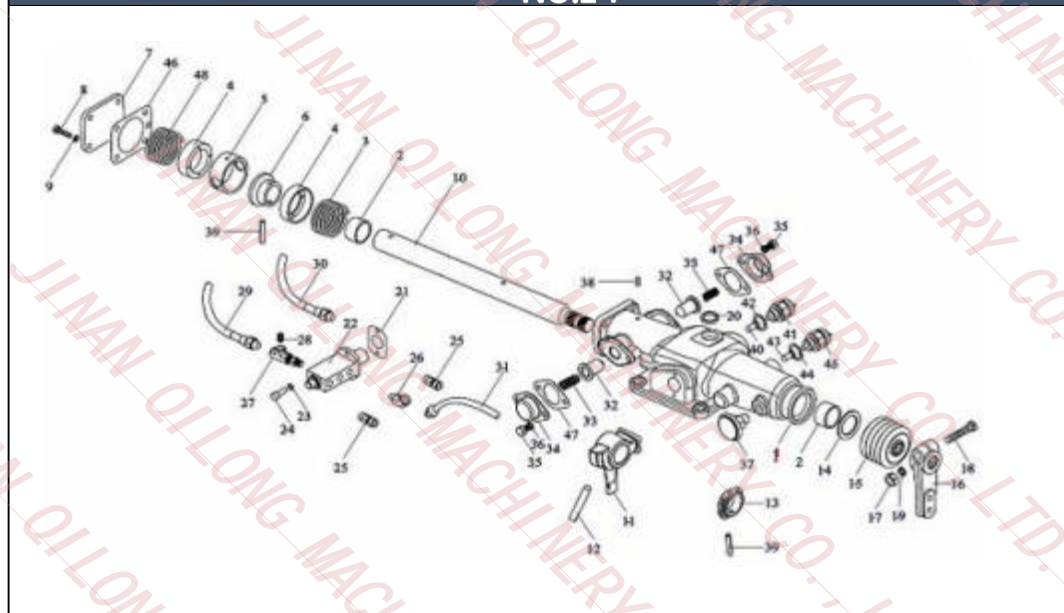

KD0488		
	Part No.	A-C03001
	CH part name	双H总成
	EN part name	Double H device assy
	RU part name	двойная h устройство, астрид
	Size: mm	435*177*70
	Weight: kg	10.9
	NO.	NO.24

Remarks:HOWO RT-11509C F96194-6

KD0490		
	Part No.	JS100-1702051-3
	CH part name	双H总成 (左置)
	EN part name	Double H device assy
	RU part name	двойная h устройство, астрид
	Size: mm	435*195*70
	Weight: kg	11.5
	NO.	NO.24

Remarks:HOWO 9JS150T On the left

KD0491		
	Part No.	JS100-1702051-3
	CH part name	双H总成 (右置)
	EN part name	Double H device assy
	RU part name	двойная h устройство, астрид
	Size: mm	435*195*70
	Weight: kg	11.5
	NO.	NO.24

Remarks:HOWO 9JS150T Right set

KD0492		
	Part No.	F96035
	CH part name	LRC换档臂
	EN part name	LRC shifting arm
	RU part name	цур смены руку
	Size: mm	118*40*25
	Weight: kg	0.37
	NO.	NO.24-16

Remarks: HOWO

	Part No.	F99882
	CH part name	副箱主轴
	EN part name	Aux main shaft
	RU part name	Главный вал делителя передач
	Size: mm	280*75
	Weight: kg	6.87
	NO.	NO.25-1

Remarks:HOWO 9JS135 11509C

	Part No.	A-C09019
	CH part name	焊接轴
	EN part name	Long lay shaft
	RU part name	Длинный промежуточный вал делителя
	Size: mm	
	Weight: kg	7.28
	NO.	NO.25-3

Remarks:HOWO 9JS135 11509C 9JS150T

AUX. GEARBOX LAY SHAFT NO.25

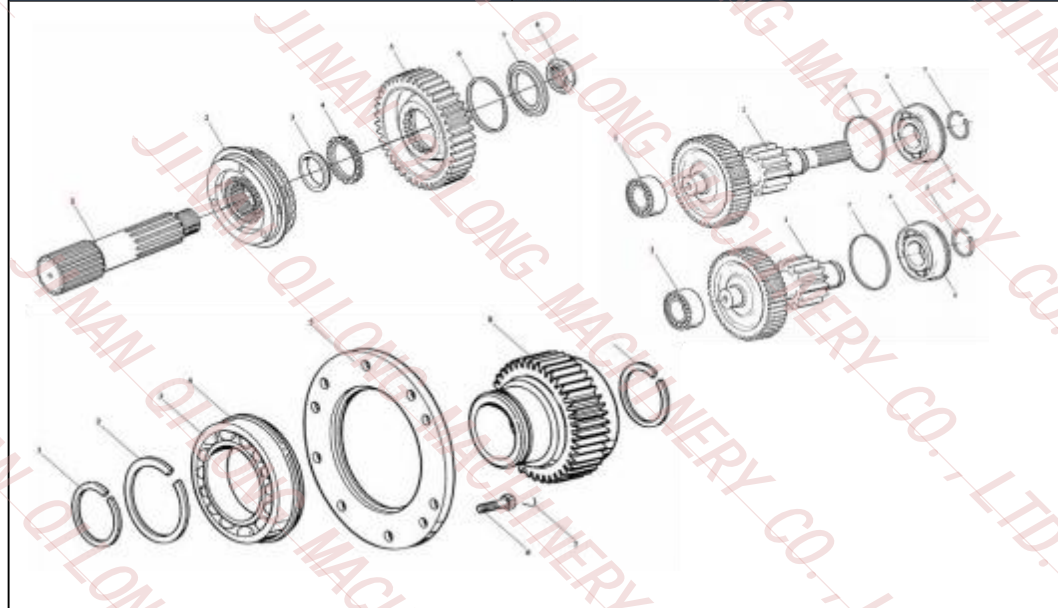

	Part No.	18222
	CH part name	焊接轴
	EN part name	Long lay shaft
	RU part name	Длинный промежуточный вал делителя
	Size: mm	180*258
	Weight: kg	7.58
	NO.	NO.25-2

Remarks:HOWO 9JS135 11509C 9JS150T A-5119

	Part No.	42307E
	CH part name	焊接轴内轴承
	EN part name	Welding shaft bearing
	RU part name	сварка вал подшипник
	Size: mm	35*80*21
	Weight: kg	0.54
	NO.	NO.25-1

Remarks:HOWO 9JS135 11509C

REAR COVER NO.26

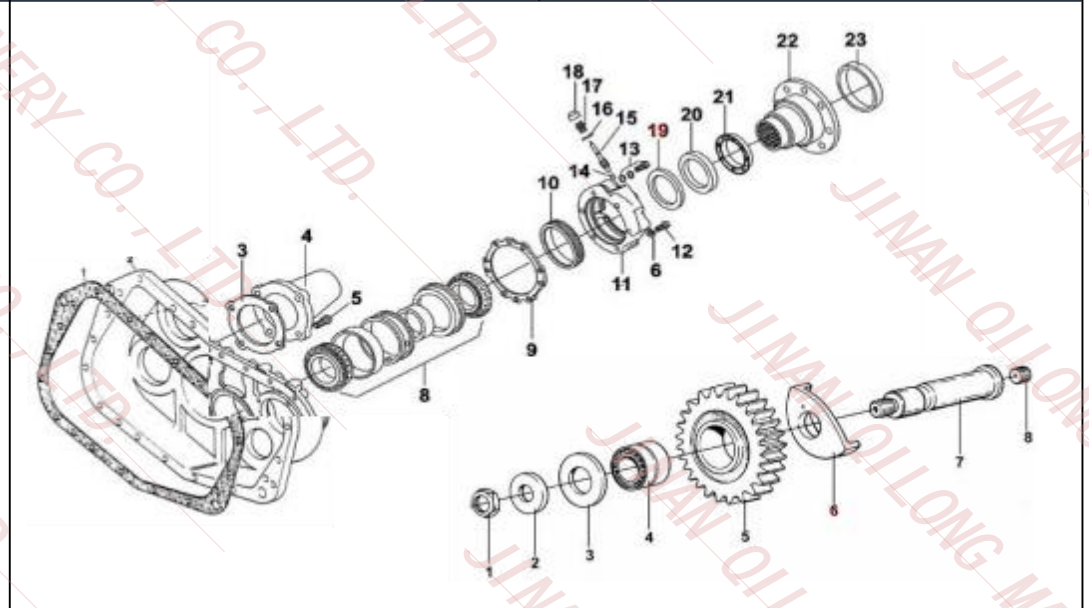

	Part No. CH part name EN part name RU part name Size: mm Weight: kg NO.	192310E 焊接轴外轴承 Welding shaft bearing сварка вал подшипник 50*110*27 1.2 NO.25-4		Part No. CH part name EN part name RU part name Size: mm Weight: kg NO.	F99967 输出轴后轴承盖 Output axle rear bearing cov К рышка задняя КПП 160*104*56 2.59 NO.26-11
Remarks:HOWO NUP310E 9JS135 11509C 9JS119			Remarks:HOWO 9JS135 11509C 9JS119 9JS150T		
	Part No. CH part name EN part name RU part name Size: mm Weight: kg NO.	A-C09005 同步器总成 Synchronizer С инхронизатор в сборе 300*300*100 4.95 NO.25-2		Part No. CH part name EN part name RU part name Size: mm Weight: kg NO.	19109 变速箱后油封 Rear oil seal Сальник 115*95*12 0.06 NO.26-19-20
Remarks:HOWO 9JS135 11509C A-5056			Remarks:HOWO 9JS135 11509C C01032		
	Part No. CH part name EN part name RU part name Size: mm Weight: kg NO.	F91055/F91054 里程表主被动齿轮 Odograph driving gear на odograph света 80*80*23/100*20*20 0.08/0,1 NO.26-10-15		Part No. CH part name EN part name RU part name Size: mm Weight: kg NO.	717813 组合轴承 Cylindrical roller bearing цилиндрические ролик с 110*68 2.2 NO.26-8
Remarks:HOWO 9JS135 11509C 9JS119 9JS150T A-5056			Remarks:HOWO 9JS135 11509C 9JS119 9JS150T		
	Part No. CH part name EN part name RU part name Size: mm Weight: kg NO.	F99975 后盖壳体 Housing Корпус задней крышки 495*340*63 14.61 NO.26-2		Part No. CH part name EN part name RU part name Size: mm Weight: kg NO.	F99902 输出法兰盘 Output flange disc выходной фланец 180 3.2 NO.26-22
Remarks:HOWO 9JS135 11509C 9JS119 A-5056 9JS150T			Remarks:HOWO 9JS135 11509C 9JS119		

KD0513		
	Part No.	16405
	CH part name	倒档中间轴
	EN part name	Reverse gear intermediate axle
	RU part name	реверсивный промежуточного вала
	Size: mm	
	Weight: kg	4.5
	NO.	NO.26-7

Remarks:HOWO 9JS135 11509C 9JS119

KD0514		
	Part No.	16403
	CH part name	杯形倒档垫圈
	EN part name	Washer
	RU part name	Шайба
	Size: mm	78*56*14
	Weight: kg	0.22
	NO.	NO.26-6

Remarks:HOWO 9JS135 11509C 9JS119

KD0515		
	Part No.	JS135-1701083
	CH part name	倒档中间齿轮
	EN part name	Reverse gear intermediate gear
	RU part name	реверсивный промежуточная передача
	Size: mm	
	Weight: kg	1.5
	NO.	NO.26-5

Remarks:HOWO 9JS135 9JS119

KD0516		
	Part No.	16757
	CH part name	倒档中间齿轮
	EN part name	Reverse gear intermediate gear
	RU part name	реверсивный промежуточная передача
	Size: mm	
	Weight: kg	1.5
	NO.	NO.26-5

Remarks:HOWO 11509C

Intermediate shaft/ Two axis **NO.27**

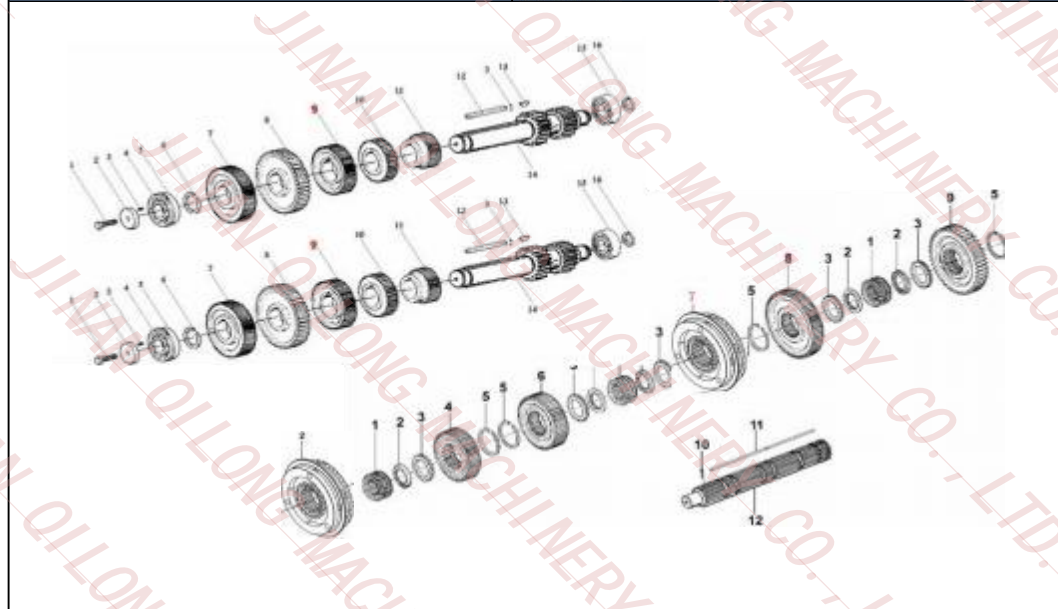

KD0517		
	Part No.	JS130T-1701180
	CH part name	一二档同步器
	EN part name	Synchronizer
	RU part name	С инхронизатор
	Size: mm	170*170*75
	Weight: kg	5.49
	NO.	NO.27-7

Remarks:HOWO 9JS135 11509C 9JS150T A-5119

KD0518		
	Part No.	16749
	CH part name	中间轴三档齿轮
	EN part name	Intermediate shaft 3rd gear
	RU part name	Шестерня 3- й передачи
	Size: mm	160*64*35
	Weight: kg	2.97
	NO.	NO.27-9

Remarks:HOWO 9JS135 11509C 9JS150T A-5119

	Part No. CH part name EN part name RU part name Size: mm Weight: kg NO.	16754 二轴低档齿轮 2Nd shaft low gear Шестерня понижающей передачи 220*80*37 4.55 NO.27-8		Part No. CH part name EN part name RU part name Size: mm Weight: kg NO.	18729 二轴 2Nd shaft Вторичный вал 455*56 5.7 NO.27-12
Remarks:HOWO 9JS135 11509C			Remarks:HOWO 9JS135 11509C 9JS150T A-5119		
	Part No. CH part name EN part name RU part name Size: mm Weight: kg NO.	JS130T-1701180 三四档同步器总 Synchronizer С инхронизатор в сборе 170*170*75 3.49 NO.27-2		Part No. CH part name EN part name RU part name Size: mm Weight: kg NO.	16118 二轴滑套 Sliding sleeve С кользаящая муфта вторичного вала 80*40*57 0.56 NO.27-1
Remarks:HOWO 9JS135 11509C			Remarks:HOWO 9JS135 11509C 9JS150T A-5119		
A shaft		NO.28			
					
	Part No. CH part name EN part name RU part name Size: mm Weight: kg NO.	19694 一轴 Input shaft Первичный вал 325*80 3.69 NO.28-7		Part No. CH part name EN part name RU part name Size: mm Weight: kg NO.	19549 中间轴 Intermediate shaft П ромежуточный вал 360*100 8.62 NO.27-14
Remarks:HOWO 9JS135 11509C			Remarks:HOWO 9JS135 11509C 9JS150T A-5119		
	Part No. CH part name EN part name RU part name Size: mm Weight: kg NO.	16566 二轴导套 Guide bush Направляющая втулка вторичного вала 82*52*40 0.55 NO.28-8			

KD0526		
	Part No.	17568
	CH part name	一轴齿轮
	EN part name	No 1 axle gear
	RU part name	вал переключения
	Size: mm	1200*500*850
	Weight: kg	2
	NO.	NO.28-6

Remarks:HOWO 9JS135 11509C

KD0527		
	Part No.	14750
	CH part name	止动环
	EN part name	Stop ring
	RU part name	стопорный кольцо
	Size: mm	
	Weight: kg	0.01
	NO.	NO.28-5

Remarks:HOWO 9JS135 11509C

KD0528		
	Part No.	16463
	CH part name	齿轮隔垫
	EN part name	Gear spacing gasket
	RU part name	передача распорка
	Size: mm	
	Weight: kg	0.2
	NO.	NO.28-4

Remarks:HOWO 9JS135 11509C

KD0529		
	Part No.	150212K
	CH part name	轴承6212ZN8
	EN part name	Single row concentric bearing with sto
	RU part name	радиальный шариковый подшипник
	Size: mm	60*110*22
	Weight: kg	0.8
	NO.	NO.28-3

Remarks:HOWO 9JS135 11509C

SWITCH GEAR / SHIFTING CYLINDER **NO.29** **Power take off**

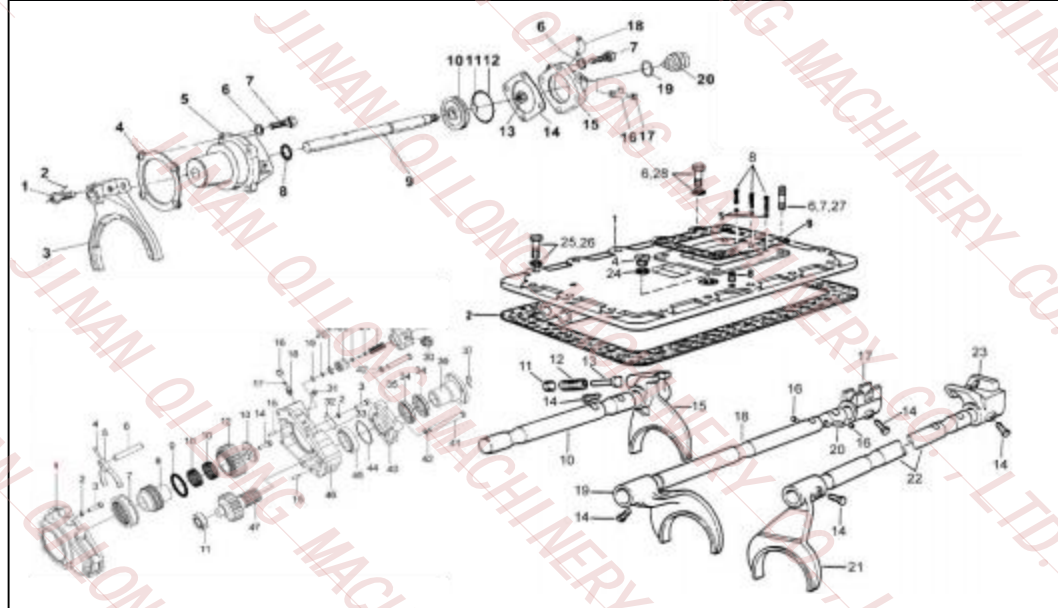

KD0530		
	Part No.	8858
	CH part name	一轴螺母
	EN part name	No 1 axle nut
	RU part name	гайка оси не 1
	Size: mm	85*53*12
	Weight: kg	0.21
	Price: usd	NO.28-1

Remarks:HOWO 9JS135 11509C

KD0531		
	Part No.	F99980
	CH part name	上盖
	EN part name	Upper cover
	RU part name	верхнего покрытия
	Size: mm	430*300*70
	Weight: kg	14
	NO.	NO.29-1

Remarks:HOWO 9JS135 11509C 9JS119