



# JINAN QILONG MACHINERY CO.,LTD.

KD0001			KD0002		
	Part No.	AZ6100004301		Part No.	AZ6100004361
	CH part name	发动机		CH part name	发动机
	EN part name	Euro II Engine new model		EN part name	Euro III Engine
	RU part name	Двигатель Новый модель E вро 2		RU part name	Двигатель общий рельс E вро3
	Size: mm	1525*660*965		Size: mm	1525*660*965
	Weight: kg	875		Weight: kg	870
	NO.			NO.	
Remarks: HOWO HW69070101 WD615.69 E2			Remarks: HOWO WD615.95 欧III共轨		
KD0003			KD0004		
	Part No.	AZ6100004575/3		Part No.	D10.38-40
	CH part name	发动机		CH part name	发动机总成
	EN part name	EGR Engine		EN part name	Euro III Engine
	RU part name	EGR Двигатель		RU part name	Двигатель общий рельс E вро3
	Size: mm	1525*660*965		Size: mm	1525*660*965
	Weight: kg	875		Weight: kg	870
	NO.			NO.	
Remarks: HOWO WD615.96EGR			Remarks: HOWO D12		
KD0005			KD0006		
	Part No.	61500010383		Part No.	AZ1246010049
	CH part name	欧II宽缸体		CH part name	共轨气缸体
	EN part name	Euro II narrow cylinder block		EN part name	Euro III common rail cylinder block
	RU part name	Блок цилиндров в сборе E вро2		RU part name	Блок цилиндров в сборе E вро3
	Size: mm	980*500*485		Size: mm	
	Weight: kg	320		Weight: kg	350
	NO.	NO.1-1		NO.	NO.1-1
Remarks: HOWO 61500010356B E2			Remarks: HOWO D12 E3		

KD0421		
	Part No.	WG9719530260
	CH part name	膨胀水箱总成
	EN part name	Expansion tank assy.
	RU part name	Расширительный бачок в сборе
	Size: mm	700*460*460
	Weight: kg	2.55
	NO.	NO.16-49

Remarks: HOWO 70

KD0423		
	Part No.	AZ9719530272
	CH part name	水箱支承缓冲垫总成
	EN part name	Cushion for water tank
	RU part name	подушки в бак с водой
	Size: mm	100*55*89
	Weight: kg	0.35
	NO.	NO.16-65

Remarks: HOWO

SUSPENSION FOR ENGINE

**NO.17**

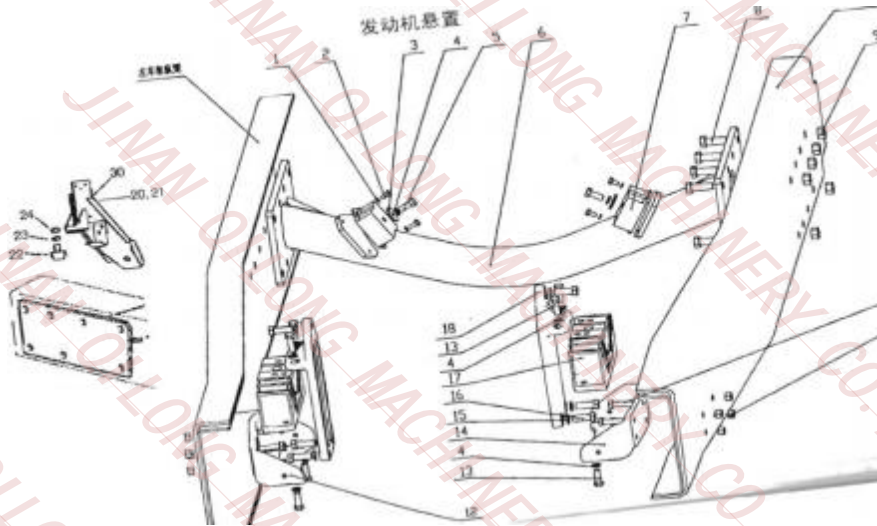

KD0422		
	Part No.	WG9632530333
	CH part name	膨胀水箱420马力
	EN part name	Expansion tank
	RU part name	Расширительный бачок в сборе 420л .с .
	Size: mm	690*450*80
	Weight: kg	2.8
	NO.	NO.16-49

Remarks:HOWO WG9112530333 336PH

KD0424		
	Part No.	WG9730530011
	CH part name	中冷器出气胶管
	EN part name	Intercooler outtake pipe
	RU part name	Патрубок интеркулера
	Size: mm	210*120*120
	Weight: kg	0.8
	NO.	NO.16

Remarks: HOWO

KD0425		
	Part No.	WG9719530318
	CH part name	中冷器胶管
	EN part name	Intercooler hose
	RU part name	Патрубок интеркулера
	Size: mm	330*360*11
	Weight: kg	0.95
	NO.	NO.16

Remarks: HOWO

KD0426		
	Part No.	WG9731590015
	CH part name	左支架
	EN part name	Left bracket
	RU part name	К ронштейн левый
	Size: mm	255*98*130
	Weight: kg	5
	Price: usd	NO.17-12

Remarks: HOWO AZ9731590015

KD0427			KD0428		
	Part No. CH part name EN part name RU part name Size: mm Weight: kg NO.	WG9100590031 发动机后支撑 Rear engine bearer О поря задняя двигателя 210*119*70 4.9 NO.17-17		Part No. CH part name EN part name RU part name Size: mm Weight: kg NO.	WG9731590016 左支架 Right bracket К ронштейн правый 255*98*130 5 NO.17-14
Remarks: HOWO 199100590031			Remarks: HOWO AZ9731590016		
KD0429			KD0430		
	Part No. CH part name EN part name RU part name Size: mm Weight: kg NO.	WG1680590095 发动机前支撑 Front engine bearer О поря передняя двигателя 117.5*70*47 0.55 NO.17-7		Part No. CH part name EN part name RU part name Size: mm Weight: kg NO.	WG9725590101 管状横梁 Crossbeam Поперечная балка 1000*250*280 18 NO.17-6
Remarks: HOWO 168000590095			Remarks: HOWO		
KD0431			KD0432		
	Part No. CH part name EN part name RU part name Size: mm Weight: kg NO.	VG9100590009 发动机右支架 Right bracket П равая опора двигателя 208*208*40 2.5 NO.17-30		Part No. CH part name EN part name RU part name Size: mm Weight: kg NO.	VG9100590006 发动机左支架 Left bracket Левая опора двигателя 210*225*68 3.05 NO.17-30
Remarks: HOWO			Remarks: HOWO		
KD0433			KD0434		
	Part No. CH part name EN part name RU part name Size: mm Weight: kg NO.	AZ9731590020 支承托架 Strut block К ронштейн крепления двигателя 350*113*66 4.18 NO.17		Part No. CH part name EN part name RU part name Size: mm Weight: kg NO.	AZ9719570002 欧II油门踏板 EuroII accelerograph pedal Педаль газа 270*60*80 0.4 NO.18-2
Remarks: HOWO AZ9725590002			Remarks: HOWO E2		

KD0007		
	Part No.	AZ1095010031
	CH part name	气缸体
	EN part name	Euro II narrow cylinder block
	RU part name	Блок цилиндров в сборе Е в ро2
	Size: mm	
	Weight: kg	320
	NO.	NO.1-1

Remarks: HOWO D10 E2 EGR

KD0009		
	Part No.	90003989480
	CH part name	碗形塞
	EN part name	Cup plug
	RU part name	Чашка с тарелкой
	Size: mm	17*8
	Weight: kg	
	NO.	NO.1-6

Remarks: HOWO WD615 D10 E2-3

Engine parts / WD615 D10

**NO.1**

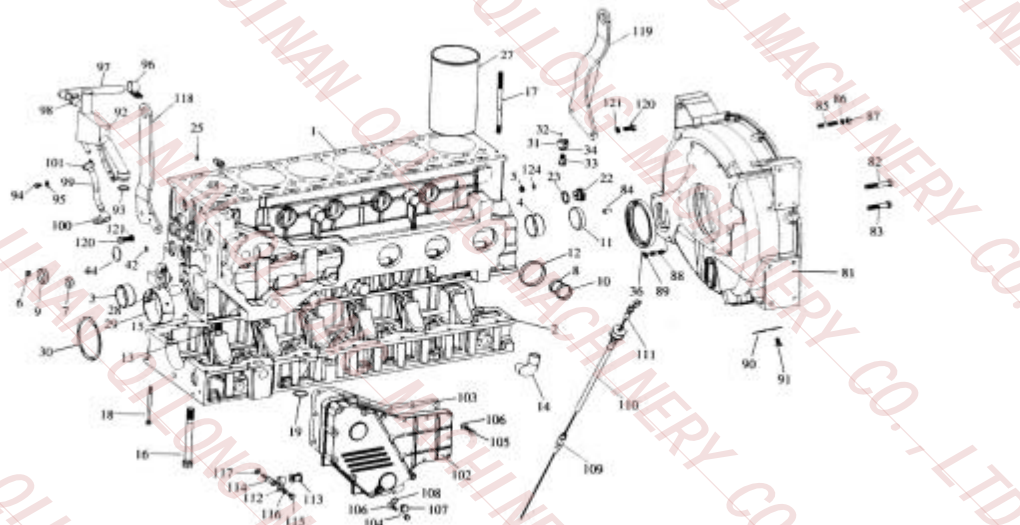

KD0008		
	Part No.	VG1560010029
	CH part name	凸轮轴衬套
	EN part name	CAM bush
	RU part name	Втулка кулачкового вала
	Size: mm	
	Weight: kg	0.55
	NO.	NO.1-3-4

Remarks: HOWO WD615 D10 E2-3 VG2600010990

KD0010		
	Part No.	90003984080
	CH part name	碗形塞
	EN part name	Cup plug
	RU part name	Чашка с тарелкой
	Size: mm	17*7.3
	Weight: kg	
	NO.	NO.1-5

Remarks: HOWO WD615 D10 E2-3

KD0011		
	Part No.	90003989204
	CH part name	碗形塞
	EN part name	Cup plug
	RU part name	Чашка с тарелкой
	Size: mm	28*12
	Weight: kg	
	NO.	NO.1-7







Remarks: HOWO WD615 D10 E2-3





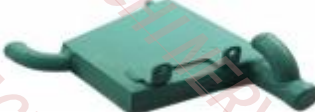

KD0012		
	Part No.	90003989289
	CH part name	碗形塞
	EN part name	Cup plug
	RU part name	Чашка с тарелкой
	Size: mm	40*12
	Weight: kg	
	NO.	NO.1-8

Remarks: HOWO WD615 D10 E2-3

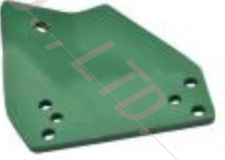

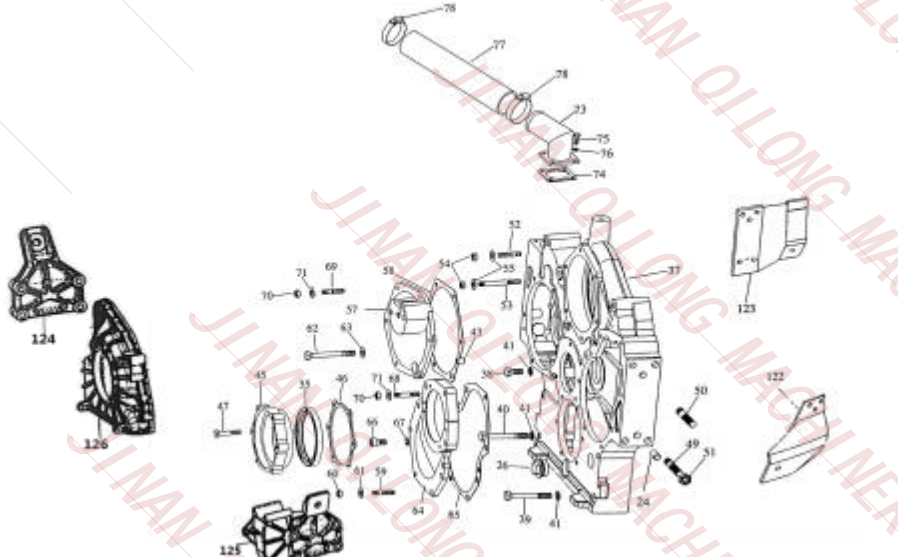



	Part No. CH part name EN part name RU part name Size: mm Weight: kg NO.	90003982121 碗形塞 Cup plug Чашка с тарелкой 45*12 NO.1-9		Part No. CH part name EN part name RU part name Size: mm Weight: kg NO.	90003989215 碗形塞 Cup plug Чашка с тарелкой 45*12 NO.1-10
Remarks: HOWO WD615 D10 E2-3			Remarks: HOWO WD615 D10 E2-3		
	Part No. CH part name EN part name RU part name Size: mm Weight: kg NO.	90003989288 碗形塞 Cup plug Чашка с тарелкой 65*14 NO.1-11		Part No. CH part name EN part name RU part name Size: mm Weight: kg Price: usd	VG1246070005 机油冷却器盖 Oil cooler cover К крышка масляного охладителя 450*300*120 3.8 NO.1-112
Remarks: HOWO WD615 D10 E2-3			Remarks: HOWO D12 E2-3		
	Part No. CH part name EN part name RU part name Size: mm Weight: kg NO.	VG1540010006 气缸套 Euro III cylinder liner Г ильза E вро3 241*126 1.45 NO.1-27		Part No. CH part name EN part name RU part name Size: mm Weight: kg NO.	VG1540010021/22 曲轴瓦 Euro III main bearing Вкладыши коренные E вро3 280*112*35 1.7 NO.1-28-29
Remarks: HOWO WD615 D10 E2-3 VG1540010006			Remarks: HOWO WD615 D10 E2-3		
	Part No. CH part name EN part name RU part name Size: mm Weight: kg NO.	VG1500010125 曲轴止推片(付) Stop washer Стопорная шайба 128*68*2 (+0.25/0.5/0.75 ) 0.047 NO.1-7-8		Part No. CH part name EN part name RU part name Size: mm Weight: kg NO.	VG1560010090 机油喷嘴组件 The oil nozzle Масляный форсунка 32*28*50 0.15 NO.1-31
Remarks: HOWO WD615 D10 E2-3 81500010125			Remarks: HOWO WD615.92-93-97E D10		

	Part No. CH part name EN part name RU part name Size: mm Weight: kg NO.	VG2600010659 机油喷嘴组件 The oil nozzle Масляный форсунка 15*11*1.6 0.12 NO.1-31		Part No. CH part name EN part name RU part name Size: mm Weight: kg NO.	KD0022 VG1047010038 前油封 Before the oil seal Передний сальник 60*80*10 0.11 NO.1-35
Remarks: HOWO WD615.95-96E D10			Remarks: HOWO WD615 D10 E2-3		
	Part No. CH part name EN part name RU part name Size: mm Weight: kg NO.	VG1500010185 气缸盖螺栓 bolt болт 195*20*20 0.25 NO.1-37		Part No. CH part name EN part name RU part name Size: mm Weight: kg NO.	KD0024 VG1047010050 后油封 After the oil seal Задний сальник 115*140*12 0.23 NO.1-36
Remarks: HOWO WD615 D10 E2-3			Remarks: HOWO WD615 D10 E2-3 D12		
	Part No. CH part name EN part name RU part name Size: mm Weight: kg NO.	AZ1557010012 飞轮壳 The flywheel shell Летающая оболочка 20 NO.1-81		Part No. CH part name EN part name RU part name Size: mm Weight: kg NO.	KD0026 VG1500010062 飞轮壳螺栓 bolt болт 0.15 NO.1-82
Remarks: HOWO WD615 D10 E2-3 614010070 E2			Remarks: HOWO WD615 D10 E2-3		
	Part No. CH part name EN part name RU part name Size: mm Weight: kg NO.	AZ1246010019 飞轮壳 The flywheel shell Летающая оболочка 21 NO.1-81		Part No. CH part name EN part name RU part name Size: mm Weight: kg NO.	KD0028 VG1500010101 飞轮壳螺栓 bolt болт 0.15 NO.1-83
Remarks: HOWO D12.38.42			Remarks: HOWO WD615 D10 E2-3		

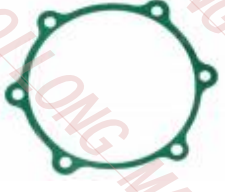
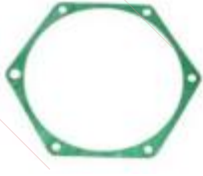
	Part No. CH part name EN part name RU part name Size: mm Weight: kg Price: usd	VG14010083B 机油冷却器盖 Oil cooler cover К крышка масляного охладителя 880*210*70 3.1 NO.1-102		Part No. CH part name EN part name RU part name Size: mm Weight: kg NO.	KD0030 VG1557010015B 油气分离器 oil- gas separator Масляный сепаратор 1 NO.1-92
Remarks: HOWO WD615 E2			Remarks: HOWO WD615 D10 E2-3		
	Part No. CH part name EN part name RU part name Size: mm Weight: kg Price: usd	VG1500010344 气缸套 Cylinder liner Г ильза 241*126 1.42 NO.1-1		Part No. CH part name EN part name RU part name Size: mm Weight: kg Price: usd	KD0032 VG1246010086 油气分离器 oil- gas separator Масляный сепаратор 120*120*300 1.1 NO.1-92
Remarks: HOWO			Remarks: HOWO D12.38.42		
	Part No. CH part name EN part name RU part name Size: mm Weight: kg Price: usd	VG1540010014 机油冷却器盖 Oil cooler cover К крышка масляного охладителя 400*320*60 1.7 NO.1-102		Part No. CH part name EN part name RU part name Size: mm Weight: kg NO.	KD0034 VG1540010015A 机油冷却器盖垫 Oil cooler cover П рокладка масляного холодильника 0.01 NO.1-103
Remarks: HOWO WD615 D10 E2-3			Remarks: HOWO WD615 D10 E2-3		
	Part No. CH part name EN part name RU part name Size: mm Weight: kg NO.	VG1095060006 发动机左支架 Front bracket engine ( left) Левая стойка 3.521 NO.2-122		Part No. CH part name EN part name RU part name Size: mm Weight: kg NO.	VG1500010600 机油尺 Oil foot Машинная линейка NO.1-111
Remarks: HOWO WD615 D10 E2-3 VG1095060116			Remarks: HOWO WD615 D10 E2-3		

	Part No. CH part name EN part name RU part name Size: mm Weight: kg NO.	VG1095060009 发动机右支架 Front bracket engine ( right) П правая стойка NO.2-123		Part No. CH part name EN part name RU part name Size: mm Weight: kg Price: usd	VG1246010023 右前支架 Front left bracket О поря левая передняя 240*180*120 3.5 NO.2-124
Remarks: HOWO WD615 D10 E2-3 VG1095060119			Remarks: HOWO D12		
Engine parts / WD615 D10 <b>NO.2</b>					
					
	Part No. CH part name EN part name RU part name Size: mm Weight: kg NO.	61557010008 正时齿轮室 Timing gearbox К крышка лобовины 515*503*85 21.15 NO.2-37		Part No. CH part name EN part name RU part name Size: mm Weight: kg Price: usd	VG1246010001 前壳盖 Before the shell cover Передний крышка 0.65 NO.2-126
Remarks: HOWO WD615 D10 E2-3			Remarks: HOWO D12.38.42		
	Part No. CH part name EN part name RU part name Size: mm Weight: kg NO.	61560010094B 正时齿轮室 Timing gearbox К крышка лобовины 515*503*85 21.15 NO.2-37		Part No. CH part name EN part name RU part name Size: mm Weight: kg NO.	61560010094B 正时齿轮室 Timing gearbox К крышка лобовины 515*503*85 21.15 NO.2-37
Remarks: HOWO WD615 D10 E2-3			Remarks: HOWO WD615 E2		



	Part No.	VG2600010928		Part No.	VG2600010934
	CH part name	前油封座		CH part name	前油封座垫片
	EN part name	Front oil seal seat		EN part name	Shim
	RU part name	Передняя башня		RU part name	П рокладка на прокладке
	Size: mm	147*125*35		Size: mm	147*125*1
	Weight: kg	0.8		Weight: kg	0.02
	NO.	NO.2-45		NO.	NO.2-46
Remarks: HOWO WD615 D10 E2-3			Remarks: HOWO WD615 D10 E2-3		
	Part No.	VG140010040		Part No.	VG2600010830
	CH part name	空压机齿轮盖垫片		CH part name	空压机齿轮盖
	EN part name	Gasket		EN part name	Cover
	RU part name	П рокладка шестерни		RU part name	Зубчатый крышка
	Size: mm			Size: mm	205*83*70
	Weight: kg	0.015		Weight: kg	
	NO.	NO.2-58		NO.	NO.2-57
Remarks: HOWO WD615 D10 E2-3			Remarks: HOWO WD615 D10 E2-3		
	Part No.	VG14010070		Part No.	VG1500010008A
	CH part name	凸轮轴齿轮盖垫片		CH part name	凸轮轴齿轮盖总成
	EN part name	Gear cover gasket		EN part name	Camshaft gear cover assy.
	RU part name	П рокладка шестерни		RU part name	К рышка
	Size: mm			Size: mm	270*185*20
	Weight: kg	0.01		Weight: kg	1.58
	NO.	NO.2-65		NO.	NO.2-64
Remarks: HOWO WD615 D10 E2-3			Remarks: HOWO WD615 D10 E2-3		
	Part No.	VG1560010028		Part No.	61500020071/12
	CH part name	加油短管组件		CH part name	曲轴总成
	EN part name	Fuel spool assembly		EN part name	Crankshaft assy.
	RU part name	Заправочный блок		RU part name	Коленвал в сборе
	Size: mm			Size: mm	1100*220*220
	Weight: kg	0.35		Weight: kg	92.08
	NO.	NO.2-73		NO.	NO.3-1
Remarks: HOWO WD615 D10 E2-3			Remarks: HOWO WD615.92E.93E.97E E3 D10		

KD0051		
	Part No.	61560020029/24
	CH part name	曲轴总成
	EN part name	Crankshaft assy.
	RU part name	Коленвал в сборе
	Size: mm	1100*220*220
	Weight: kg	111
	Price: usd	NO.3-1

Remarks: HOWO WD615.95E.96E EGR D10

The crankshaft flywheel

**NO.3**

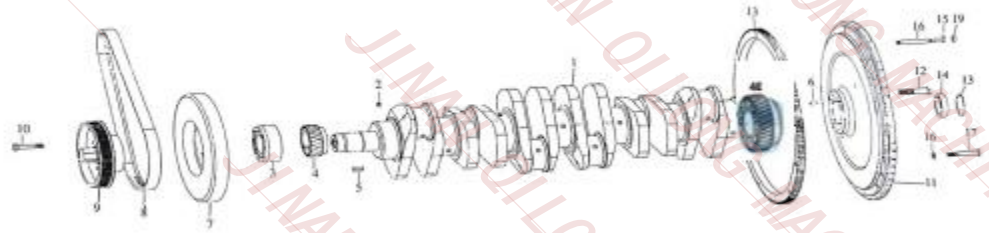

KD0052		
	Part No.	VG1246060014
	CH part name	曲轴总成
	EN part name	Crankshaft assy.
	RU part name	Коленвал в сборе
	Size: mm	
	Weight: kg	115
	Price: usd	NO.3-1

Remarks: HOWO D12

KD0053		
	Part No.	61800020022
	CH part name	曲轴总成
	EN part name	Crankshaft assy.
	RU part name	Коленвал в сборе
	Size: mm	1100*220*220
	Weight: kg	115
	Price: usd	NO.3-1

Remarks: HOWO WD618

KD0054		
	Part No.	VG1500020070
	CH part name	法兰
	EN part name	Flange
	RU part name	фланец
	Size: mm	75*42
	Weight: kg	1.45
	Price: usd	NO.3-3

Remarks: HOWO WD615 D10

KD0055		
	Part No.	VG14020038
	CH part name	曲轴齿轮
	EN part name	Crankshaft gear
	RU part name	Шестерня коленвала
	Size: mm	84*40
	Weight: kg	0.75
	Price: usd	NO.3-4

Remarks: HOWO WD615 E3 D10

KD0056		
	Part No.	VG1246020012
	CH part name	曲轴前齿轮
	EN part name	Crankshaft front gear
	RU part name	Шестерня передняя коленвала
	Size: mm	110*110*25
	Weight: kg	1.3
	Price: usd	NO.3-4

Remarks: HOWO D12

	Part No. CH part name EN part name RU part name Size: mm Weight: kg Price: usd	VG1560020010 曲轴硅油减震器 Vibration damper А мортизатор коленвала 280*38 12.48 NO.3-7		Part No. CH part name EN part name RU part name Size: mm Weight: kg Price: usd	KD0058 VG1246020011 曲轴后齿轮 Crankshaft rear gear Задняя шестерня коленчатого вала 120*120*35 1.4 NO.3-4E
Remarks: HOWO D10			Remarks: HOWO D12		
	Part No. CH part name EN part name RU part name Size: mm Weight: kg Price: usd	VG1540020003 曲轴硅油减震器 Vibration damper А мортизатор коленвала 280*40 12.91 NO.3-7		Part No. CH part name EN part name RU part name Size: mm Weight: kg Price: usd	KD0059 61800020012 减震器 Vibration damper А мортизатор коленвала 280*46 13 NO.3-7
Remarks: HOWO WD615 EGR E3 D10			Remarks: HOWO WD618		
	Part No. CH part name EN part name RU part name Size: mm Weight: kg Price: usd	KD0061 VG1246020002 硅油减振器 Vibration damper А мортизатор 280*45 12.91 NO.3-7		Part No. CH part name EN part name RU part name Size: mm Weight: kg Price: usd	KD0062 VG2600020253 风扇多楔带 Fan multi wedge belt Ремень клинчатый вентилятора 8PK1050 0.12 NO.3-8
Remarks: HOWO D12			Remarks: HOWO WD615 EGR D10 VG1062060007 VG1062060006		
	Part No. CH part name EN part name RU part name Size: mm Weight: kg Price: usd	KD0063 VG1246060082 多楔带 Fan multi wedge belt Ремень клинчатый вентилятора 10PK1282 0.15 NO.3-8		Part No. CH part name EN part name RU part name Size: mm Weight: kg Price: usd	KD0064 AZ1500090065 三角皮带 V belt Т реугольный пояс AV*13*1050 0.12 NO.3-8
Remarks: HOWO D12			Remarks: HOWO WD618		

	Part No. CH part name EN part name RU part name Size: mm Weight: kg Price: usd	VG1560020020 皮带轮 Pulley Ш кив 4.7 NO.3-9		Part No. CH part name EN part name RU part name Size: mm Weight: kg Price: usd	61800020025 皮带轮 Pulley Ш кив 5 NO.3-9
Remarks: HOWO D10 WD615 E3			Remarks: HOWO WD618		
	Part No. CH part name EN part name RU part name Size: mm Weight: kg Price: usd	90003802558 皮带轮螺栓 Bolt болт 0.11 NO.3-10		Part No. CH part name EN part name RU part name Size: mm Weight: kg Price: usd	VG1246020001 皮带轮 Pulley Ш кив 12 NO.3-9
Remarks: HOWO WD615 WD618 D10			Remarks: HOWO WD615		
	Part No. CH part name EN part name RU part name Size: mm Weight: kg Price: usd	VG1246020004 皮带轮螺栓 Bolt болт 0.11 NO.3-10		Part No. CH part name EN part name RU part name Size: mm Weight: kg Price: usd	AZ1540020205 飞轮 Flywheel Маховик 480*480*67 22.95 NO.3-11
Remarks: HOWO D12			Remarks: HOWO WD615 E3 D10 VG1540020004 AZ1092020002		
	Part No. CH part name EN part name RU part name Size: mm Weight: kg Price: usd	61500020023 飞轮 flywheel Маховик 22.8 NO.3-11		Part No. CH part name EN part name RU part name Size: mm Weight: kg Price: usd	AZ1246020025A 飞轮 flywheel Маховик 22.95 NO.3-11
Remarks: HOWO WD618			Remarks: HOWO D12		

KD0073		
	Part No.	VG1246020010
	CH part name	飞轮螺栓
	EN part name	Bolt
	RU part name	болт
	Size: mm	
	Weight: kg	0.15
Price: usd	NO.3-12	

Remarks: HOWO D12

KD0075		
	Part No.	VG2600020208
	CH part name	飞轮齿圈136齿16
	EN part name	Flywheel ring gear
	RU part name	Венец маховика 136зубьев
	Size: mm	480*430*20
	Weight: kg	4.63
Price: usd	NO.3-13	

Remarks: HOWO WD615 E3 D10 D12 81400020015

piston rod **NO.4**

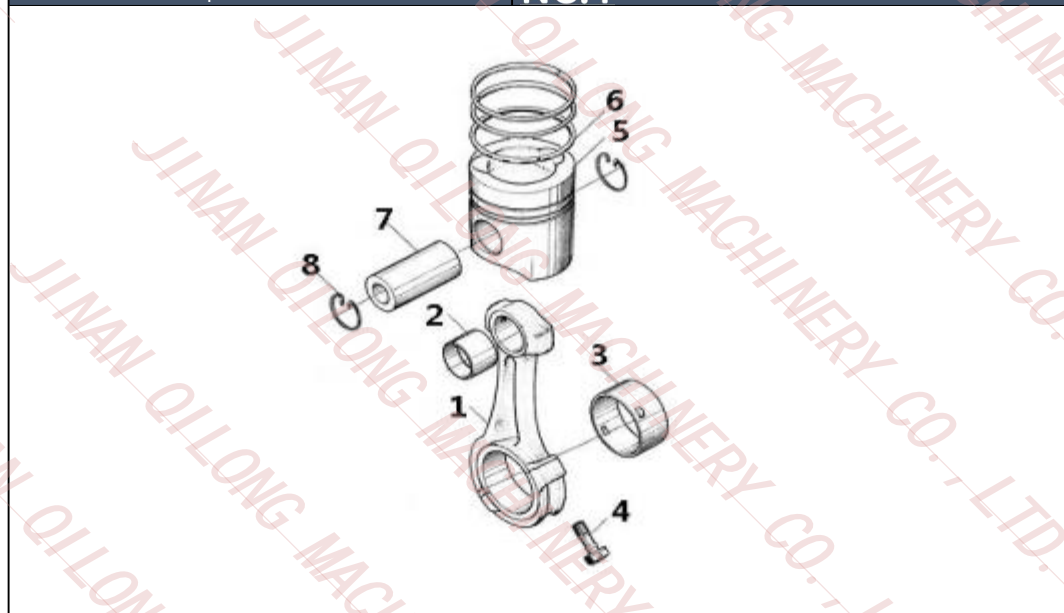

KD0074		
	Part No.	VG1500020046
	CH part name	飞轮螺栓
	EN part name	Bolt
	RU part name	болт
	Size: mm	
	Weight: kg	0.13
Price: usd	NO.3-12	

Remarks: HOWO WD615 E3 WD618 D10

KD0076		
	Part No.	81500020009
	CH part name	飞轮齿圈
	EN part name	Flywheel ring gear
	RU part name	Венец маховика
	Size: mm	
	Weight: kg	4.5
Price: usd	NO.3-13	

Remarks: HOWO WD618

KD0077		
	Part No.	90003311416
	CH part name	飞轮轴承
	EN part name	flywheel bearing
	RU part name	Подшипниковый подшипник
	Size: mm	80*20
	Weight: kg	0.15
Price: usd	NO.3-14	

Remarks: HOWO WD615 WD618 D10 D12

KD0078		
	Part No.	161500030008
	CH part name	连杆体
	EN part name	Euro III Connecting rod
	RU part name	Шатун Е впр3
	Size: mm	336*145*43
	Weight: kg	3.52
Price: usd	NO.4-1	







Remarks: HOWO WD615 E3 D10

	Part No. CH part name EN part name RU part name Size: mm Weight: kg Price: usd	AZ1246030008 连杆体 Connecting rod Шатун 3.6 N0.4-1		Part No. CH part name EN part name RU part name Size: mm Weight: kg Price: usd	KD0080 61800030040 连杆体 Connecting rod Шатун 3.5 N0.4-1
Remarks: HOWO D12			Remarks: HOWO WD618		
	Part No. CH part name EN part name RU part name Size: mm Weight: kg Price: usd	VG1500030077 连杆衬套 Connecting rod bush Втулка шатуна 41*54 0.15 N0.4-2		Part No. CH part name EN part name RU part name Size: mm Weight: kg Price: usd	KD0082 VG1246030010 连杆衬套 Connecting rod bush Втулка шатуна 0.15 N0.4-2
Remarks: HOWO WD615 D10			Remarks: HOWO D12		
	Part No. CH part name EN part name RU part name Size: mm Weight: kg Price: usd	61500030018 连杆衬套 Connecting rod bush Втулка шатуна 0.12 N0.4-2		Part No. CH part name EN part name RU part name Size: mm Weight: kg Price: usd	KD0084 VG1540030015/16 欧III连杆瓦(套) Euro III connecting rod bearing Вкладыши шатуна Е вро3 160*90*35 1.11 N0.4-1-2
Remarks: HOWO WD618			Remarks: HOWO WD615 E3 VG1500010046		
	Part No. CH part name EN part name RU part name Size: mm Weight: kg NO.	VG1246030011/12 欧III连杆瓦(套) connecting rod bearing Вкладыши шатуна N0.4-3		Part No. CH part name EN part name RU part name Size: mm Weight: kg NO.	KD0086 VG1560037034/15 欧III连杆瓦(套) Euro III connecting rod bearing Вкладыши шатуна Е вро3 160*90*35 1.11 N0.4-3
Remarks: HOWO D12			Remarks: HOWO D10		



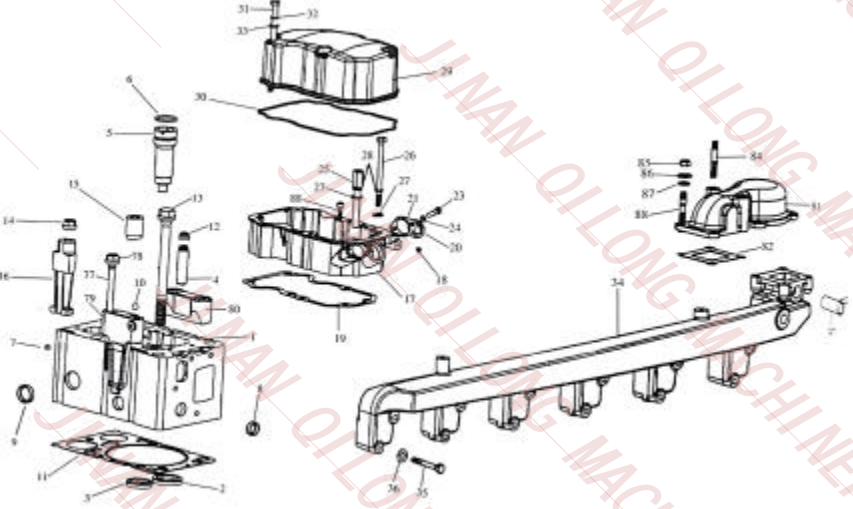





	Part No. CH part name EN part name RU part name Size: mm Weight: kg NO.	61800030049 欧III连杆瓦(套) connecting rod bearing Вкладыши шатуна 160*90*35 1.11 N0.4-3		Part No. CH part name EN part name RU part name Size: mm Weight: kg NO.	VG1560030020/33 欧II连杆瓦(套) Connecting rod bearing Вкладыши шатунна Е вро2 (нижний) 160*90*35 1.11 N0.4-3
Remarks: HOWO WD618			Remarks: HOWO WD615 E2		
	Part No. CH part name EN part name RU part name Size: mm Weight: kg Price: usd	VG1500030023 连杆螺栓 Connecting rod bolt Болт шатуна 73*23 0.09 N0.4-4		Part No. CH part name EN part name RU part name Size: mm Weight: kg Price: usd	VG1246030013 连杆螺栓 Connecting rod bolt Болт шатуна 70*15*15 0.1 N0.4-4
Remarks: HOWO WD615 D10			Remarks: HOWO D12		
	Part No. CH part name EN part name RU part name Size: mm Weight: kg Price: usd	61800030019 连杆螺栓 Connecting rod bolt Болт шатуна 20*20*100 0.11 N0.4-4		Part No. CH part name EN part name RU part name Size: mm Weight: kg Price: usd	VG1560030010 活塞(4A) Piston (4A) Поршень 123*123*126 2.1 N0.4-5
Remarks: HOWO WD618			Remarks: HOWO WD615.92E.93E.97E		
	Part No. CH part name EN part name RU part name Size: mm Weight: kg Price: usd	VG1246030001 活塞 Piston Поршень 2.98 N0.4-5		Part No. CH part name EN part name RU part name Size: mm Weight: kg Price: usd	VG1560037011 活塞 Piston Поршень 3 N0.4-5
Remarks: HOWO D12			Remarks: HOWO D10		









	Part No. CH part name EN part name RU part name Size: mm Weight: kg Price: usd	KD0095  61800030042 活塞 Piston Поршень 3.01 NO.4-8-1		Part No. CH part name EN part name RU part name Size: mm Weight: kg Price: usd	KD0096  VG1560030040 活塞环 Piston ring Кольца поршневые 130*130*80 0.63 NO.4-6
Remarks: HOWO WD618			Remarks: HOWO WD615 E2 WD618		
	Part No. CH part name EN part name RU part name Size: mm Weight: kg Price: usd	KD0097  VG1560030013 活塞销 Piston pin Поршневой палец 105*49 1.26 NO.4-7		Part No. CH part name EN part name RU part name Size: mm Weight: kg Price: usd	KD0098  VG1540030005 活塞环 Piston ring Кольца поршневые 130*130*80 0.63 NO.4-6
Remarks: HOWO WD615 WD618 D10 61560030013			Remarks: HOWO WD615 E3 D10 D12		
	Part No. CH part name EN part name RU part name Size: mm Weight: kg Price: usd	KD0099  VG1246030002 活塞销 Piston pin Поршневой палец 1.3 NO.4-7		Part No. CH part name EN part name RU part name Size: mm Weight: kg Price: usd	KD0100  VG1560030012 活塞销挡圈 Circlip Кольцо стопорное поршневого пальца 56.6*47.4*1.8 0.01 NO.4-8
Remarks: HOWO D12			Remarks: HOWO WD615 D10		
	Part No. CH part name EN part name RU part name Size: mm Weight: kg Price: usd	KD0101  81560030012 活塞销挡圈 Circlip Кольцо стопорное поршневого пальца 0.01 NO.4-8		Part No. CH part name EN part name RU part name Size: mm Weight: kg Price: usd	KD0102  VG1246030003 活塞销挡圈 Circlip Кольцо стопорное поршневого пальца 0.01 NO.4-8
Remarks: HOWO WD618			Remarks: HOWO D12		

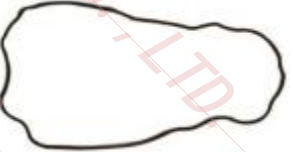

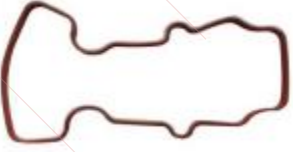
	Part No. CH part name EN part name RU part name Size: mm Weight: kg Price: usd	AZ1096040028 气缸盖 Cylinder head Головка цилиндра 14 NO.5-1		Part No. CH part name EN part name RU part name Size: mm Weight: kg Price: usd	AZ1095040123 气缸盖 Cylinder head Головка цилиндра 14 NO.5-1
Remarks: HOWO WD615 D10			Remarks: HOWO WD615 AZ1095040124		
Cylinder head <b>NO.5</b>					
				Part No. CH part name EN part name RU part name Size: mm Weight: kg Price: usd	61560040058 气缸盖 Cylinder head Головка цилиндра 14 NO.5-1
			Remarks: HOWO WD618		
				Part No. CH part name EN part name RU part name Size: mm Weight: kg Price: usd	AZ1099040002 气缸盖 Cylinder head Головка цилиндра 14 NO.5-1
			Remarks: HOWO WD615 AZ1099040003/1四气门 EGR		
	Part No. CH part name EN part name RU part name Size: mm Weight: kg Price: usd	VG1560040057 进气门座 EuroII intake valve seat С иденъе впуского клапана Е вро2 56*46*11 0.049 NO.5-2		Part No. CH part name EN part name RU part name Size: mm Weight: kg Price: usd	AZ1246040010 气缸盖 Cylinder head Головка цилиндра 250*180*150 15 NO.5-1
Remarks: HOWO WD615 E2-3 D10 两气门			Remarks: HOWO D12 AZ1246040011		

	Part No. CH part name EN part name RU part name Size: mm Weight: kg Price: usd	VG1560040037 排气门座 EuroII exhaust valve seat С иденье выпускного клапана E вро2 53*42*12 0.049 NO.5-3		Part No. CH part name EN part name RU part name Size: mm Weight: kg Price: usd	KD0110 VG1540040007 排气门座 EuroII exhaust valve seat С иденье выпускного клапана E вро2 0.049 NO.5-3
Remarks: HOWO WD615 E2-3 D10 两气门			Remarks: HOWO D10 四气门 WD615 EGR		
	Part No. CH part name EN part name RU part name Size: mm Weight: kg Price: usd	VG1246040012 进气门座 EuroII intake valve seat С иденье впуского клапана E вро2 0.049 NO.5-2		Part No. CH part name EN part name RU part name Size: mm Weight: kg Price: usd	KD0112 VG1540040006 进气门座 EuroII intake valve seat С иденье впуского клапана E вро2 0.049 NO.5-2
Remarks: HOWO D12 E2			Remarks: HOWO D10 四气门 WD615 EGR		
	Part No. CH part name EN part name RU part name Size: mm Weight: kg NO.	VG1246040013 排气门座 EuroII exhaust valve seat С иденье выпускного клапана E вро2 0.049 NO.5-3		Part No. CH part name EN part name RU part name Size: mm Weight: kg NO.	KD0114 VG1540040015 欧III气缸垫 Euro II cylinder head gasket П рокладка цилиндра E вро3 250*150*3 0.13 NO.5-11
Remarks: HOWO D12 E2			Remarks: HOWO D10 E3 WD615 VG1500040065		
	Part No. CH part name EN part name RU part name Size: mm Weight: kg NO.	61500040049 气缸垫 Euro II cylinder head gasket П рокладка цилиндра E вро2 0.129 NO.5-11		Part No. CH part name EN part name RU part name Size: mm Weight: kg NO.	KD0116 VG1246040021 气缸垫 Euro III cylinder head gasket П рокладка цилиндра E вро3 0.132 NO.5-11
Remarks: HOWO WD618			Remarks: HOWO D12		

	Part No. CH part name EN part name RU part name Size: mm Weight: kg NO.	61560040032 气门杆密封套 Oil seal Колпачок маслосъёмный D =14 0.01 NO.5-12		Part No. CH part name EN part name RU part name Size: mm Weight: kg NO.	KD0118 VG1540040016 气门杆密封套 Oil seal Колпачок маслосъёмный D =12 0.01 NO.5-12
Remarks: HOWO WD618			Remarks: HOWO WD615 D10		
	Part No. CH part name EN part name RU part name Size: mm Weight: kg NO.	VG1099040053 摇臂罩下罩总成 Rocker lower hood Колпак капота 0.8 NO.5-17		Part No. CH part name EN part name RU part name Size: mm Weight: kg NO.	KD0120 VG1246050027 气门杆密封套 Oil seal Колпачок маслосъёмный 9*11.5*10 0.01 NO.5-12
Remarks: HOWO WD615 E3 EGR			Remarks: HOWO D12		
	Part No. CH part name EN part name RU part name Size: mm Weight: kg NO.	VG1099040020 摇臂罩下罩总成 Rocker lower hood Колпак капота 0.8 NO.5-17		Part No. CH part name EN part name RU part name Size: mm Weight: kg NO.	KD0122 VG1500040023 气缸盖主螺栓 Cylinder head bolt Болт главный головки блока цилиндра 195*30*30 0.25 NO.5-13
Remarks: HOWO D10 E3 四气门			Remarks: HOWO WD615 D10 WD618 61500040023		
	Part No. CH part name EN part name RU part name Size: mm Weight: kg NO.	VG1246040005 气缸盖罩衬垫 Lower rock arm cover gasket П прокладка крышки клапанов (нижний) 250*150*1 0.01 NO.5-19		Part No. CH part name EN part name RU part name Size: mm Weight: kg NO.	KD0124 VG1246040020 气缸盖主螺栓 Cylinder head bolt Болт главный головки блока цилиндра 0.25 NO.5-13
Remarks: HOWO D12			Remarks: HOWO D12		

<p>KD0125</p> 	<p>Part No. CH part name EN part name RU part name Size: mm Weight: kg NO.</p>	<p>VG1099040018 上罩密封圈 Upper rock arm cover seal П рокладка крышки клапанов (верхний) 220*150*1 0.01 NO.5-30</p>	<p>KD0126</p> 	<p>Part No. CH part name EN part name RU part name Size: mm Weight: kg NO.</p>	<p>VG1246040030 摇臂罩下罩总成 Rocker lower hood Колпак капота 0.8 NO.5-17</p>
Remarks: HOWO D10 VG1099040052			Remarks: HOWO D12 VG1246040009		
<p>KD0127</p> 	<p>Part No. CH part name EN part name RU part name Size: mm Weight: kg NO.</p>	<p>VG1246040023 气缸盖罩密封圈 Upper rock arm cover seal П рокладка крышки клапанов (верхний) 0.021 NO.5-30</p>	<p>KD0128</p> 	<p>Part No. CH part name EN part name RU part name Size: mm Weight: kg NO.</p>	<p>VG1099040022 摇臂罩下罩衬垫 Lower rock arm cover gasket П рокладка крышки клапанов (нижний) 0.01 NO.5-19</p>
Remarks: HOWO D12			Remarks: HOWO D10 四气门		
<p>KD0129</p> 	<p>Part No. CH part name EN part name RU part name Size: mm Weight: kg NO.</p>	<p>VG1099040019 摇臂罩上罩 Upper cylinder head cover Капот головки блока цилиндра(верхний) 0.9 NO.5-29</p>	<p>KD0130</p> 	<p>Part No. CH part name EN part name RU part name Size: mm Weight: kg NO.</p>	<p>VG1099040051 摇臂罩下罩衬垫 Lower rock arm cover gasket П рокладка крышки клапанов (нижний) 230*150*1 0.01 NO.5-19</p>
Remarks: HOWO D10 E3 四气门			Remarks: HOWO WD615 E3 EGR		
<p>KD0131</p> 	<p>Part No. CH part name EN part name RU part name Size: mm Weight: kg NO.</p>	<p>VG1246040003 气缸盖罩 Upper cylinder head cover Капот головки блока цилиндра(верхний) 250*150*90 0.83 NO.5-29</p>	<p>KD0132</p> 	<p>Part No. CH part name EN part name RU part name Size: mm Weight: kg NO.</p>	<p>VG14040021 气缸盖罩衬垫 EuroII cylinder head cover gasket П рокладка капота головки блока цилиндра 165*122*2 0.01 NO.5-19</p>
Remarks: HOWO D12 E2			Remarks: HOWO WD615 E2 61560040039 VG14040065		

	Part No. CH part name EN part name RU part name Size: mm Weight: kg NO.	VG1560040031 气门导管 Valve guide Направляющая клапана 71*16*10 0.049 NO.5-4		Part No. CH part name EN part name RU part name Size: mm Weight: kg NO.	KD0134 VG1099040049 摇臂罩上罩 Upper cylinder head cover Капот головки блока цилиндра(верхний) 220*138*80 0.9 NO.5-29
Remarks: HOWO WD615 D10 两气门			Remarks: HOWO WD615 EGR		
	Part No. CH part name EN part name RU part name Size: mm Weight: kg NO.	KD0135 VG1246040014 气门导管 Valve guide Направляющая клапана 50*30 0.05 NO.5-4		Part No. CH part name EN part name RU part name Size: mm Weight: kg NO.	KD0136 VG1500040067 气缸盖罩 Upper cylinder head cover Капот головки блока цилиндра(верхний) 80*120*68 0.46 NO.5-29
Remarks: HOWO D12			Remarks: HOWO WD615 EGR D10 两气门 VG140400065		
	Part No. CH part name EN part name RU part name Size: mm Weight: kg NO.	KD0137 VG1096040001A 喷油器衬套 Injector sleeve Втулка на форсунки 100*20*20 0.102 NO.5-5		Part No. CH part name EN part name RU part name Size: mm Weight: kg NO.	KD0138 VG1540040008 气门导管 Valve guide Направляющая клапана 71*11 0.06 NO.5-4
Remarks: HOWO D10 VG2600040099 VG1092040306			Remarks: HOWO D10 四气门 EGR		
	Part No. CH part name EN part name RU part name Size: mm Weight: kg NO.	KD0139 VG1540040231 出水管 exhalent siphon Дренажная труба 980*130*70 2.8 NO.5-34		Part No. CH part name EN part name RU part name Size: mm Weight: kg NO.	KD0140 VG1246040016 喷油器衬套 Injector sleeve Втулка на форсунки 120*26*23 0.6 NO.5-5
Remarks: HOWO D10 四气门 VG1096040330 两气门			Remarks: HOWO D12 VG1540040009		

Distribution agency **NO.6**

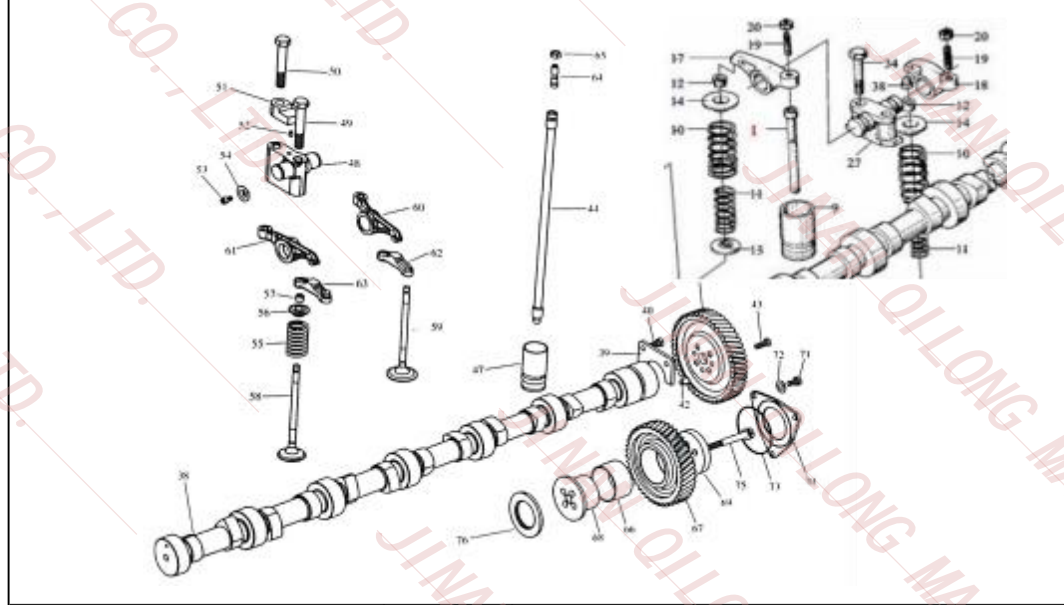

KD0141		
Part No.	VG1540040232	
CH part name	节温器盖(无丝)	
EN part name	Thermostat housing	
RU part name	Корпус термостата	
Size: mm	180*80*70	
Weight: kg	0.45	
NO.	NO.5-81	

Remarks: HOWO D10 E3 四气门

KD0142		
Part No.	VG1096040332	
CH part name	节温器盖	
EN part name	Thermostat housing	
RU part name	Корпус термостата	
Size: mm		
Weight: kg	0.42	
NO.	NO.5-81	

Remarks: HOWO D10 E3 VG1500040105

KD0143		
Part No.	VG1560050042	
CH part name	欧II进气门	
EN part name	EuroII intake valve	
RU part name	Клапан впускной E вpо2	
Size: mm	154*54.5	
Weight: kg	0.23	
NO.	NO.6-59	

Remarks: HOWO D10 E2 两气门 WD615

KD0144		
Part No.	VG1246050021	
CH part name	进气门	
EN part name	EuroIII intake valve	
RU part name	Клапан впускной E вpо3	
Size: mm		
Weight: kg	0.23	
NO.	NO.6-59	









Remarks: HOWO D12

KD0145		
Part No.	VG1560050041	
CH part name	排气门	
EN part name	EuroII exhaust valve	
RU part name	Клапан выпускной E вpо2	
Size: mm	154*49.8	
Weight: kg	0.23	
NO.	NO.6-58	

Remarks: HOWO D10 E2 两气门 WD615

KD0146		
Part No.	VG1246050022	
CH part name	排气门	
EN part name	EuroIII exhaust valve	
RU part name	Клапан выпускной E вpо3	
Size: mm		
Weight: kg	0.23	
NO.	NO.6-58	

Remarks: HOWO D12

	Part No. CH part name EN part name RU part name Size: mm Weight: kg NO.	VG1540050014 欧III排气门 EuroIII exhaust valve Клапан выпускной E вро3 159*39.5 0.14 NO.6-58		Part No. CH part name EN part name RU part name Size: mm Weight: kg NO.	KD0148 VG1540050015 进气门 EuroIII intake valve Клапан впускной E вро3 183*41.8 0.15 NO.6-59
Remarks: HOWO D10 E3 WD615 四气门			Remarks: HOWO D10 E3 WD615 四气门		
	Part No. CH part name EN part name RU part name Size: mm Weight: kg NO.	VG1500050096 凸轮轴 Euro II camshaft Распредвал E вро2 980*70*70 10.5 NO.6-38		Part No. CH part name EN part name RU part name Size: mm Weight: kg NO.	KD0149 VG1246050038 凸轮轴 camshaft Распредвал 10 NO.6-38
Remarks: HOWO WD615 E2			Remarks: HOWO D12		
	Part No. CH part name EN part name RU part name Size: mm Weight: kg NO.	VG1540050004 凸轮轴 camshaft Распредвал 10 NO.6-38		Part No. CH part name EN part name RU part name Size: mm Weight: kg NO.	KD0151 VG14050133 止推片 Stop shim Кольцо стопорное кулачкового вала 80*46*6 0.11 NO.6-39
Remarks: HOWO D10			Remarks: HOWO WD615 D10		
	Part No. CH part name EN part name RU part name Size: mm Weight: kg NO.	VG1246050039 止推片 Stop shim Кольцо стопорное кулачкового вала 0.12 NO.6-39		Part No. CH part name EN part name RU part name Size: mm Weight: kg NO.	KD0153 VG14050053 凸轮正时齿轮 Camshaft gear Шестерня коленвала 180*180*45 2.8 NO.6-41
Remarks: HOWO D12			Remarks: HOWO WD615 D10		







	Part No. CH part name EN part name RU part name Size: mm Weight: kg NO.	VG1246050036 凸轮轴齿轮 Camshaft gear Шестерня коленвала 180*180*45 2.58 NO.6-41		Part No. CH part name EN part name RU part name Size: mm Weight: kg NO.	VG1560050052 凸轮轴中间齿轮 Camshaft mid-gear shaft Шестерня промежуточная распредвала 140*40 1.94 NO.6-67
Remarks: HOWO D12			Remarks: HOWO WD615 D10		
	Part No. CH part name EN part name RU part name Size: mm Weight: kg NO.	VG1246050060 中间齿轮 Intermediate gear Шестерня промежуточная 180*180*45 2.28 NO.6-67		Part No. CH part name EN part name RU part name Size: mm Weight: kg NO.	VG1560050044 中间齿轮轴 Intermediate gear shaft Ось промежуточной шестерни 0.59 NO.6-68
Remarks: HOWO D12			Remarks: HOWO WD615 D10		
	Part No. CH part name EN part name RU part name Size: mm Weight: kg NO.	VG1246050020 欧II气门推杆 EuroII valve push rod Толкатель клапана E vro2 375*16*16 0.198 NO.6-44		Part No. CH part name EN part name RU part name Size: mm Weight: kg NO.	VG1246050034 中间齿轮轴 Intermediate gear shaft Ось промежуточной шестерни 0.52 NO.6-68
Remarks: HOWO WD615 D12			Remarks: HOWO D12		
	Part No. CH part name EN part name RU part name Size: mm Weight: kg NO.	VG1500050032 气门挺柱 Tappet Направляющая клапана 72*38 0.269 NO.6-9		Part No. CH part name EN part name RU part name Size: mm Weight: kg NO.	VG1246050029 气门挺柱 Tappet Направляющая клапана 72*38*38 0.269 NO.6-9
Remarks: HOWO ED615 D10			Remarks: HOWO D12		

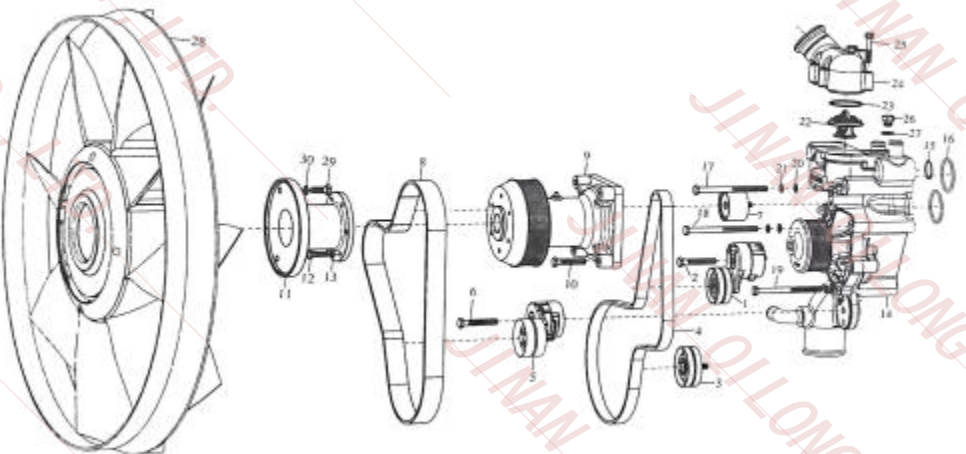

<p>KD0163</p> 	<p>Part No. CH part name EN part name RU part name Size: mm Weight: kg NO.</p>	<p>VG1540050008 气门推杆 Euro III valve push rod Толкатель клапана Е вро3 393*16*16 0.198 NO.6-1</p>	<p>KD0164</p> 	<p>Part No. CH part name EN part name RU part name Size: mm Weight: kg NO.</p>	<p>VG1246050008 气门摇臂 intake valve rock arm Р ычаг впускной 0.43 NO.6-60</p>
<p>Remarks: HOWO D10 E3</p>			<p>Remarks: HOWO D12</p>		
<p>KD0165</p> 	<p>Part No. CH part name EN part name RU part name Size: mm Weight: kg NO.</p>	<p>VG14050049 排气门摇臂 Euro II exhaust valve rock arm Р ычаг выпускной Е вро2 87*24*45 0.18 NO.6-61</p>	<p>KD0166</p> 	<p>Part No. CH part name EN part name RU part name Size: mm Weight: kg NO.</p>	<p>VG1540050016 进气门摇臂 Euro III intake valve rock arm Р ычаг впускной Е вро3 116*40*20 0.4 NO.6-60</p>
<p>Remarks: HOWO WD615 E2</p>			<p>Remarks: HOWO WD615 E3 VG1540050032 D10</p>		
<p>KD0167</p> 	<p>Part No. CH part name EN part name RU part name Size: mm Weight: kg NO.</p>	<p>VG14050048 进气门摇臂 Euro II intake valve rock arm Р ычаг впускной Е вро2 116*40*24 0.24 NO.6-60</p>	<p>KD0168</p> 	<p>Part No. CH part name EN part name RU part name Size: mm Weight: kg NO.</p>	<p>VG1540050017 排气门摇臂 Euro III exhaust valve rock arm Р ычаг выпускной Е вро3 116*40*20 0.18 NO.6-61</p>
<p>Remarks: HOWO WD615 E2</p>			<p>Remarks: HOWO WD615 E3 VG1540050033 D10</p>		
<p>KD0169</p> 	<p>Part No. CH part name EN part name RU part name Size: mm Weight: kg NO.</p>	<p>VG14050010 气门间隙调整螺栓及螺母 Bolt and nut Болт и гайка регулировочные 40*10*10 0.03 NO.6-64-65</p>	<p>KD0170</p> 	<p>Part No. CH part name EN part name RU part name Size: mm Weight: kg NO.</p>	<p>VG1540050018 进气门桥 Euro III intake valve pons Мост впускной Е вро3 73*15*23 0.119 NO.6-80</p>
<p>Remarks: HOWO WD615 D10 VG2130050065</p>			<p>Remarks: HOWO E3 D12</p>		

	Part No. CH part name EN part name RU part name Size: mm Weight: kg NO.	VG1246050006 摇臂轴总成 Rocker arm shaft Ось качалки 0.56 NO.6-48		Part No. CH part name EN part name RU part name Size: mm Weight: kg NO.	VG1540050019 排气门桥 EuroIII exhaust valve pons Мост выпускной Е вро3 73*15*23 0.119 NO.6-83
Remarks: HOWO D12			Remarks: HOWO E3 D12 VG1540059028		
	Part No. CH part name EN part name RU part name Size: mm Weight: kg NO.	VG14050119 气门摇臂座 EuroII valve rock arm seat О пора коромысла клапанов Е вро2 75*72*45 0.61 NO.6-48		Part No. CH part name EN part name RU part name Size: mm Weight: kg NO.	VG1540050010D 气门摇臂座 EuroIII valve rock arm seat О пора коромысла клапанов Е вро3 72*76*20 0.85 NO.6-48
Remarks: HOWO WD615 E2			Remarks: HOWO D10 E3		
	Part No. CH part name EN part name RU part name Size: mm Weight: kg NO.	VG1500050002 气门外弹簧 Outer valve spring П ружина клапана наружная 60*40 0.05 NO.6-10		Part No. CH part name EN part name RU part name Size: mm Weight: kg NO.	VG1246050005 摇臂座 valve rock arm seat О пора коромысла клапанов 0.6 NO.6-48
Remarks: HOWO WD615 D10 VG1500050002 D12			Remarks: HOWO D12		
	Part No. CH part name EN part name RU part name Size: mm Weight: kg NO.	VG1500050001 气门内弹簧 Inner valve spring П ружина клапана внутренняя 60*30 0.03 NO.6-10		Part No. CH part name EN part name RU part name Size: mm Weight: kg NO.	VG1500050025 气门锁夹 Valve cone Сухарь клапана 9*13*6 0.01 NO.6-56
Remarks: HOWO WD615 D10 VG1246050024 D12			Remarks: HOWO WD615 D10 VG1500050021 VG1246050028 D12		

	Part No. CH part name EN part name RU part name Size: mm Weight: kg NO.	VG1500050105 气门帽 Air valve cap К рышка воздушного клапана 20*8 0.018 NO.6-57		Part No. CH part name EN part name RU part name Size: mm Weight: kg NO.	VG14050017 进气门弹簧下座 spring bottom seat Н ижняя стойка пружины 0.01 NO.6-13
Remarks: HOWO WD615 D10			Remarks: HOWO WD615 D10		
	Part No. CH part name EN part name RU part name Size: mm Weight: kg NO.	VG1246050025 气门弹簧上座 spring upper seat Верхняя часть пружины 0.015 NO.6-14		Part No. CH part name EN part name RU part name Size: mm Weight: kg NO.	VG1500050109 气门弹簧上座 spring upper seat Верхняя часть пружины 0.015 NO.6-14
Remarks: HOWO D12			Remarks: HOWO WD615 D10		
	Part No. CH part name EN part name RU part name Size: mm Weight: kg NO.	VG1246050026 气门弹簧下座 spring bottom seat Н ижняя стойка пружины 0.01 NO.6-13		Part No. CH part name EN part name RU part name Size: mm Weight: kg NO.	VG1246060042 水泵总成 Water pump (multi wedge) Помпа (ручейковый шкив) 350*240*200 18 NO.7-14
Remarks: HOWO D12			Remarks: HOWO D12		
	Part No. CH part name EN part name RU part name Size: mm Weight: kg NO.	VG1500060051 水泵总成 Water pump (multi wedge) Помпа (ручейковый шкив) 250*215 18.09 NO.7-14		Part No. CH part name EN part name RU part name Size: mm Weight: kg NO.	VG1500060050 水泵总成 Water pump assy. Водяной насос в сборе 380*360*200 16.5 NO.7-14
Remarks: HOWO D10			Remarks: HOWO WD615		

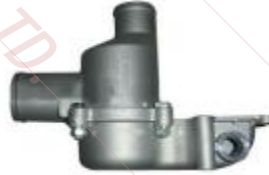
cooling system/ D1 2		NO.7																			
				KD0187																	
						<table border="1"> <tr><td>Part No.</td><td>VG1246060070</td></tr> <tr><td>CH part name</td><td>风扇托架总成</td></tr> <tr><td>EN part name</td><td>Fan bracket assembly</td></tr> <tr><td>RU part name</td><td>кронштейн вентилятора</td></tr> <tr><td>Size: mm</td><td>50*30</td></tr> <tr><td>Weight: kg</td><td>1</td></tr> <tr><td>NO.</td><td>NO.7-9</td></tr> </table>		Part No.	VG1246060070	CH part name	风扇托架总成	EN part name	Fan bracket assembly	RU part name	кронштейн вентилятора	Size: mm	50*30	Weight: kg	1	NO.	NO.7-9
Part No.	VG1246060070																				
CH part name	风扇托架总成																				
EN part name	Fan bracket assembly																				
RU part name	кронштейн вентилятора																				
Size: mm	50*30																				
Weight: kg	1																				
NO.	NO.7-9																				
Remarks: HOWO D12				KD0188																	
						<table border="1"> <tr><td>Part No.</td><td>VG1500060240</td></tr> <tr><td>CH part name</td><td>中间法兰</td></tr> <tr><td>EN part name</td><td>Interspace flange</td></tr> <tr><td>RU part name</td><td>Фланец промежуточный вентилятора</td></tr> <tr><td>Size: mm</td><td>170*170*65</td></tr> <tr><td>Weight: kg</td><td>3.4</td></tr> <tr><td>NO.</td><td>NO.7-11</td></tr> </table>		Part No.	VG1500060240	CH part name	中间法兰	EN part name	Interspace flange	RU part name	Фланец промежуточный вентилятора	Size: mm	170*170*65	Weight: kg	3.4	NO.	NO.7-11
Part No.	VG1500060240																				
CH part name	中间法兰																				
EN part name	Interspace flange																				
RU part name	Фланец промежуточный вентилятора																				
Size: mm	170*170*65																				
Weight: kg	3.4																				
NO.	NO.7-11																				
Remarks: HOWO D10 E3 WD615				KD0189																	
		<table border="1"> <tr><td>Part No.</td><td>VG1246060046A</td></tr> <tr><td>CH part name</td><td>中间法兰</td></tr> <tr><td>EN part name</td><td>Interspace flange</td></tr> <tr><td>RU part name</td><td>Фланец промежуточный вентилятора</td></tr> <tr><td>Size: mm</td><td>170*170*65</td></tr> <tr><td>Weight: kg</td><td>3.5</td></tr> <tr><td>NO.</td><td>NO.7-11</td></tr> </table>		Part No.	VG1246060046A	CH part name	中间法兰	EN part name	Interspace flange	RU part name	Фланец промежуточный вентилятора	Size: mm	170*170*65	Weight: kg	3.5	NO.	NO.7-11	KD0190			
Part No.	VG1246060046A																				
CH part name	中间法兰																				
EN part name	Interspace flange																				
RU part name	Фланец промежуточный вентилятора																				
Size: mm	170*170*65																				
Weight: kg	3.5																				
NO.	NO.7-11																				
Remarks: HOWO D12 VG1038060243						<table border="1"> <tr><td>Part No.</td><td>VG1500060241</td></tr> <tr><td>CH part name</td><td>中间法兰</td></tr> <tr><td>EN part name</td><td>Interspace flange</td></tr> <tr><td>RU part name</td><td>Фланец промежуточный вентилятора</td></tr> <tr><td>Size: mm</td><td>120*120*160</td></tr> <tr><td>Weight: kg</td><td>1.5</td></tr> <tr><td>NO.</td><td>NO.7-11</td></tr> </table>		Part No.	VG1500060241	CH part name	中间法兰	EN part name	Interspace flange	RU part name	Фланец промежуточный вентилятора	Size: mm	120*120*160	Weight: kg	1.5	NO.	NO.7-11
Part No.	VG1500060241																				
CH part name	中间法兰																				
EN part name	Interspace flange																				
RU part name	Фланец промежуточный вентилятора																				
Size: mm	120*120*160																				
Weight: kg	1.5																				
NO.	NO.7-11																				
Remarks: HOWO D10 E3 WD615				KD0191																	
		<table border="1"> <tr><td>Part No.</td><td>VG1246060023</td></tr> <tr><td>CH part name</td><td>节温器壳体</td></tr> <tr><td>EN part name</td><td>Thermostat housing</td></tr> <tr><td>RU part name</td><td>Корпус термостата</td></tr> <tr><td>Size: mm</td><td>160*140*100</td></tr> <tr><td>NO.</td><td>0.42</td></tr> <tr><td>NO.</td><td>NO.7-24</td></tr> </table>		Part No.	VG1246060023	CH part name	节温器壳体	EN part name	Thermostat housing	RU part name	Корпус термостата	Size: mm	160*140*100	NO.	0.42	NO.	NO.7-24	KD0192			
Part No.	VG1246060023																				
CH part name	节温器壳体																				
EN part name	Thermostat housing																				
RU part name	Корпус термостата																				
Size: mm	160*140*100																				
NO.	0.42																				
NO.	NO.7-24																				
Remarks: HOWO D12 E2						<table border="1"> <tr><td>Part No.</td><td>VG1099060001</td></tr> <tr><td>CH part name</td><td>节温器总成</td></tr> <tr><td>EN part name</td><td>New model thermostat(80 °C)</td></tr> <tr><td>RU part name</td><td>Термостат нового модели(80 °C)</td></tr> <tr><td>Size: mm</td><td></td></tr> <tr><td>Weight: kg</td><td>1.02</td></tr> <tr><td>NO.</td><td>NO.7-24</td></tr> </table>		Part No.	VG1099060001	CH part name	节温器总成	EN part name	New model thermostat(80 °C)	RU part name	Термостат нового модели(80 °C)	Size: mm		Weight: kg	1.02	NO.	NO.7-24
Part No.	VG1099060001																				
CH part name	节温器总成																				
EN part name	New model thermostat(80 °C)																				
RU part name	Термостат нового модели(80 °C)																				
Size: mm																					
Weight: kg	1.02																				
NO.	NO.7-24																				
Remarks: HOWO D10 VG1096069601																					

	Part No. CH part name EN part name RU part name Size: mm Weight: kg NO.	VG1246060024 节温器芯 Thermostat core Термостат без корпуса 80*80*60 0.12 NO.7-22		Part No. CH part name EN part name RU part name Size: mm Weight: kg NO.	KD0194 VG1560060023 水管接头 Water pipe joint соединение труб 260*68 0.31 NO.7-24
Remarks: HOWO A7 D12			Remarks: HOWO D10 WD615 VG1560060022A		
	Part No. CH part name EN part name RU part name Size: mm Weight: kg NO.	VG14060136 节温器 New model thermostat(80 °C) Термостат нового модели(80 °C) 100*160*140 0.8 NO.7-22		Part No. CH part name EN part name RU part name Size: mm Weight: kg NO.	KD0196 VG1500060117 节温器 New model thermostat(71 °C) Термостат нового модели(71 °C) 160*140*100 0.8 NO.7-22
Remarks: HOWO D10			Remarks: HOWO D10		
	Part No. CH part name EN part name RU part name Size: mm Weight: kg NO.	VG1500061202 节温器芯 Thermostat core(80 °C) Термостат без корпуса(80 °C) 80*80*70 0.2 NO.7-22		Part No. CH part name EN part name RU part name Size: mm Weight: kg NO.	KD0198 VG1500061201 节温器芯 Thermostat core(71 °C) Термостат без корпуса (71 °C) 80*80*70 0.2 NO.7-22
Remarks: HOWO D10			Remarks: HOWO D10		
	Part No. CH part name EN part name RU part name Size: mm Weight: kg NO.	VG14060135 节温器 Old model thermostat(80 °C) Термостат старого модели(80 °C) 180*135*100 0.51 NO.7-22		Part No. CH part name EN part name RU part name Size: mm Weight: kg NO.	KD0201 VG1500060116 节温器 Old model thermostat(71 °C) Термостат старого модели(71 °C) 180*135*100 0.51 NO.7-22
Remarks: HOWO WD615			Remarks: HOWO WD615		

	Part No. CH part name EN part name RU part name Size: mm Weight: kg Price: usd	VG1500061203 节温器壳体 Thermostat housing Корпус термостата 160*140*100 0.4 NO.7-24		Part No. CH part name EN part name RU part name Size: mm Weight: kg NO.	KD0203 VG1246060082 多楔带 Fan multi wedge belt Ремень клинчатый вентилятора 10PK1282 0.12 NO.7-8
Remarks: HOWO D10			Remarks: HOWO D12 10PK1282		
	Part No. CH part name EN part name RU part name Size: mm Weight: kg NO.	VG2600020253 风扇多楔带 Fan multi wedge belt Ремень клинчатый вентилятора 1050*30*10 0.12 NO.7-8		Part No. CH part name EN part name RU part name Size: mm Weight: kg NO.	KD0205 VG1246060008 多楔带 Fan multi wedge belt Ремень клинчатый вентилятора 6PK1425 0.12 NO.7-4
Remarks: HOWO D10 8PK1050			Remarks: HOWO D12 6PK1425		
	Part No. CH part name EN part name RU part name Size: mm Weight: kg NO.	VG2600020251 风扇多楔带 Fan multi wedge belt Ремень клинчатый вентилятора 1062*30*10 0.12 NO.7-8		Part No. CH part name EN part name RU part name Size: mm Weight: kg NO.	KD0207 VG1500060228 三角风扇带 Fan triangle belt Ремень 1125*13*10 0.1 NO.7-8
Remarks: HOWO D10 8PK1062			Remarks: HOWO WD615 AV13*1125		
	Part No. CH part name EN part name RU part name Size: mm Weight: kg NO.	VG1246060001 自动涨紧轮 Automatic pulley Ролик натяжной 150*80*80 1.6 NO.7-1		Part No. CH part name EN part name RU part name Size: mm Weight: kg NO.	KD0209 VG1246060002 自动涨紧轮 Automatic pulley Ролик натяжной 150*80*80 1.6 NO.7-5
Remarks: HOWO A7 D12			Remarks: HOWO A7 D12		

	Part No. CH part name EN part name RU part name Size: mm Weight: kg NO.	VG2600060313 自动涨紧轮 Automatic pulley Ролик натяжной 150*80*80 1.6 NO.7-1		Part No. CH part name EN part name RU part name Size: mm Weight: kg NO.	VG1246060004 平惰轮 Idle pulley Ролик паразитный приводного ремня 80*80*45 0.5 NO.7-3
Remarks: HOWO D10			Remarks: HOWO D12		
	Part No. CH part name EN part name RU part name Size: mm Weight: kg NO.	VG1246060047 平惰轮 Idle pulley Ролик паразитный приводного ремня 60*60*45 0.4 NO.7-7		Part No. CH part name EN part name RU part name Size: mm Weight: kg NO.	VG1560060069 张紧轮总成 Tension wheel Натяжное колесо 100*40 2.1 NO.7-3
Remarks: HOWO D12			Remarks: HOWO WD615 E2		
	Part No. CH part name EN part name RU part name Size: mm Weight: kg NO.	VG1246060028 O型圈 "O" ring "O" резиновая прокладка 0.01 NO.10-16		Part No. CH part name EN part name RU part name Size: mm Weight: kg NO.	VG1246060025 节温器O型圈 "O" ring "O" резиновая прокладка 0.01 NO.7-23
Remarks: HOWO D12			Remarks: HOWO D12		
	Part No. CH part name EN part name RU part name Size: mm Weight: kg NO.	VG1500060131 风扇叶 Fan Вентилятор 620*85 2.13 NO.7-28		Part No. CH part name EN part name RU part name Size: mm Weight: kg NO.	VG1246060051 环形硅油风扇总成 Fan Вентилятор φ758 3.16 NO.7-28
Remarks: HOWO WD615 E2			Remarks: HOWO D12		

	Part No. CH part name EN part name RU part name Size: mm Weight: kg NO.	VG1099060201 φ704环形硅油风扇总成 Fan with ring(704mm) Вентилятор охлаж диаметр 704mm 704*85 3.21 NO.7-28		Part No. CH part name EN part name RU part name Size: mm Weight: kg NO.	VG2600060446 环形硅油风扇总成 Fan with ring(646mm) Вентилятор охлаж диаметр 646mm 640*85 3.1 NO.7-28
Remarks:HOWO D10			Remarks: HOWO D10 VG2600060447 φ 590		
	Part No. CH part name EN part name RU part name Size: mm NO. NO.	VG1500060047 风扇叶 Fan Вентилятор 570*85 2.35 NO.7-28		Part No. CH part name EN part name RU part name Size: mm Weight: kg NO.	VG1500070021 45mm机油泵总成 Oil pump E vro2 Масляный насос в сборе 290*260*1.05 10.07 NO.8-2
Remarks: HOWO			Remarks:HOWO WD615 E2 EGR D10 AZ1500070021		
	Part No. CH part name EN part name RU part name Size: mm Weight: kg NO.	VG1246070022 机油泵 Oil pump Масляный насос в сборе 290*260*1.05 10.1 NO.8-2		Part No. CH part name EN part name RU part name Size: mm Weight: kg NO.	VG1800070051 集滤器 Suction filter assy. Маслоприемник 320*190*138 0.45 NO.8-3
Remarks: HOWO A7 D12			Remarks : HOWO WD615 D10 EGR VG1500070082		
	Part No. CH part name EN part name RU part name Size: mm Weight: kg NO.	VG1246070014 集滤器 Suction filter assy. Маслоприемник 290*190*138 0.32 NO.8-3		Part No. CH part name EN part name RU part name Size: mm Weight: kg NO.	VG1500070097 主油道限压阀总成 Main oil gallery pressure limiting valve assy. П предохранительный клапан 78*27 0.23 NO.8-27
Remarks: HOWO D12			Remarks: HOWO WD615 D10 VG1500070099		



lubrication system **NO.8**

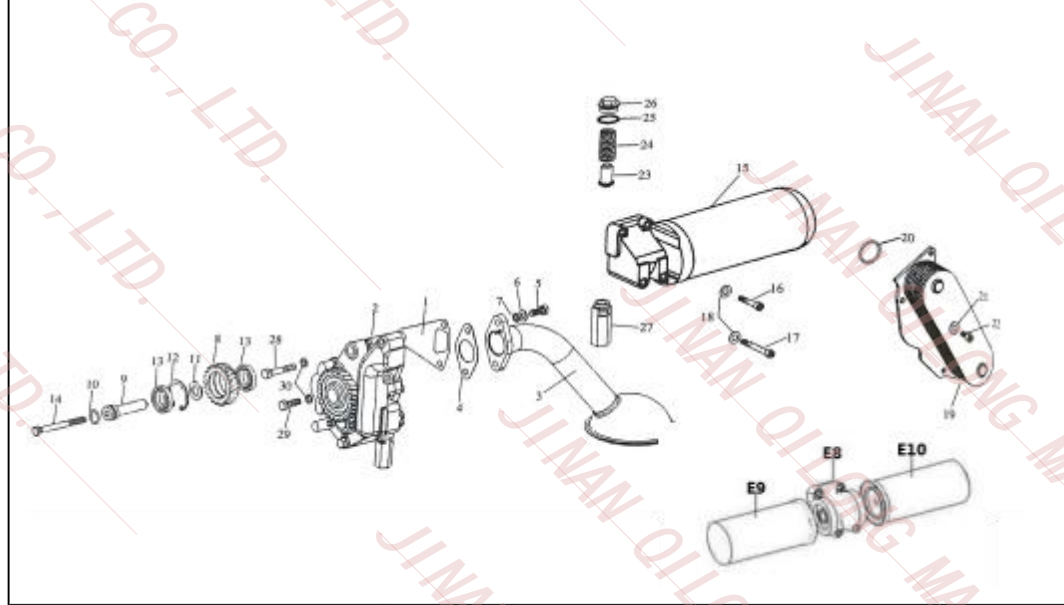

	Part No.	VG1560070099
	CH part name	机油泵限压冷阀总成
	EN part name	Oil pump pressure limiting valve assy.
	RU part name	П редохранительный клапан в сборе
	Size: mm	75*23
	Weight: kg	0.15
	NO.	NO.8-27

Remarks: HOWO WD615 D10 EGR

	Part No.	VG1540070005
	CH part name	机油滤清器总成
	EN part name	Oil filter
	RU part name	Масляный фильтр
	Size: mm	
	Weight: kg	1.5
NO.	NO.8-15	

Remarks: HOWO D10

	Part No.	VG1500070051
	CH part name	机油滤清器座
	EN part name	EuroII oil filter seat
	RU part name	Головка фильтра масляного
	Size: mm	103*101*88
	Weight: kg	0.94
	NO.	NO.8-E8

Remarks: HOWO WD615 D10 E2

	Part No.	VG61000070005
	CH part name	机油滤芯
	EN part name	EuroII oil filter
	RU part name	Масляный фильтр E вро2
	Size: mm	210*96
	Weight: kg	0.81
	NO.	NO.8-E9

Remarks: HOWO WD615 E2 D10









	Part No.	VG1246070002
	CH part name	机油滤清器芯
	EN part name	Euro oil filter
	RU part name	Масляный фильтр
	Size: mm	260*109
	NO.	1.24
	NO.	NO.8-15







Remarks: HOWO D12

	Part No.	VG1246070003
	CH part name	机油滤清器座
	EN part name	Oil filter holder
	RU part name	маслоочиститель
	Size: mm	7*24
	Weight: kg	0.85
	NO.	NO.8-E8

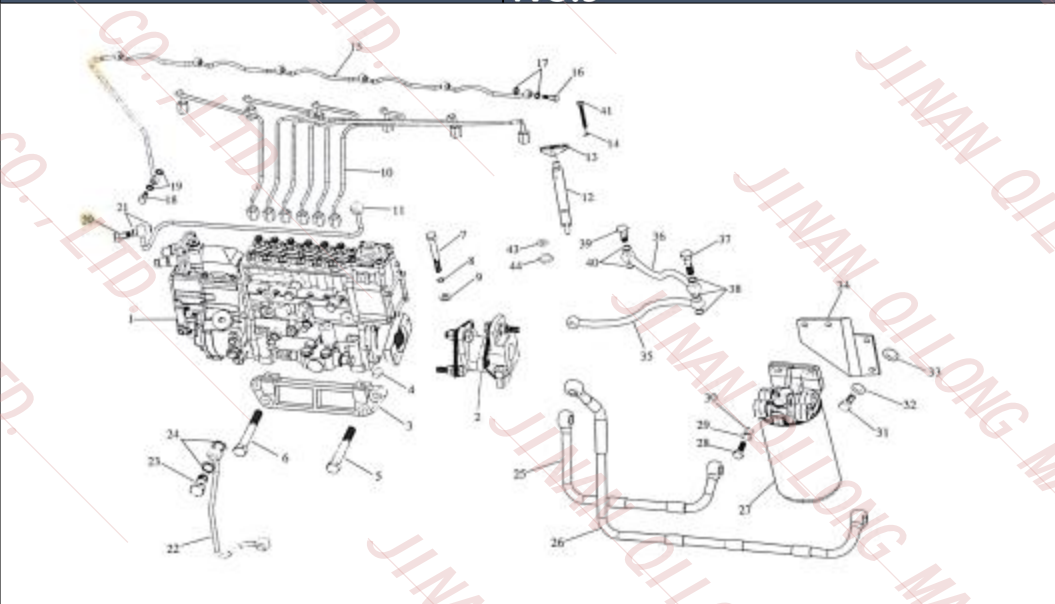







Remarks: HOWO D12

	Part No. CH part name EN part name RU part name Size: mm Weight: kg NO.	VG1246070001 机油滤清器总成 Oil filter Масляный фильтр 360*120*120 1.75 NO.8-15		Part No. CH part name EN part name RU part name Size: mm Weight: kg NO.	KD0234 VG1246070012 机油冷却器 Oil cooler core assy. Теплообменник 200*100*100 3.12 NO.8-19
Remarks: HOWO D12			Remarks: HOWO D12 WD618		
	Part No. CH part name EN part name RU part name Size: mm Weight: kg NO.	VG1500019336 机油冷却器 ( 8片) Oil cooler core assy. Теплообменник 256*138*50 2.88 NO.8-19		Part No. CH part name EN part name RU part name Size: mm Weight: kg NO.	KD0236 VG1500070050 机油滤清器总成EGR Euro oil filter Масляный фильтр 360*120*120 1.75 NO.8-E8-E9
Remarks: HOWO WD615 E2-E3 D10 EGR VG1500010334			Remarks: HOWO WD615 D10 EGR		
	Part No. CH part name EN part name RU part name Size: mm Weight: kg NO.	VG1246080097 喷油泵总成 Injection pump ТНВД 700*280*440 25 NO.9-1		Part No. CH part name EN part name RU part name Size: mm Weight: kg NO.	KD0238 VG1560080023 喷油泵371P Injection pump ТНВД 460*300*200 24.15 NO.9-1
Remarks: HOWO D12.42.30 E2 VG1246080038			Remarks: HOWO WD615.47		
	Part No. CH part name EN part name RU part name Size: mm Weight: kg NO.	VG1560080022 喷油泵336P Injection pump ТНВД 460*300*200 24.15 NO.9-1		Part No. CH part name EN part name RU part name Size: mm Weight: kg Price: usd	KD0240 VG1560080276-1 203喷油嘴 Injection nozzle Распылитель форсунки Е вро2 60*25*25 0.05 NO.9-1
Remarks: HOWO WD615.69			Remarks: HOWO WD615		

	Part No. CH part name EN part name RU part name Size: mm Weight: kg Price: usd	X1700S 高压油泵柱塞 Plunger Плунжерная пара 113*70*30 0.3 NO.9-1		Part No. CH part name EN part name RU part name Size: mm Weight: kg Price: usd	VG1560080305-1 204喷油嘴 Injection nozzle Распылитель форсунки E вро2 60*25*25 0.05 NO.9-1
Remarks: HOWO WD615			Remarks: HOWO WD615		
	Part No. CH part name EN part name RU part name Size: mm Weight: kg Price: usd	614080719 输油泵 Hand oil pump Топливоподкачивающий насос 105*105*105 1.358 NO.9-1		Part No. CH part name EN part name RU part name Size: mm Weight: kg Price: usd	R61540080017A-1 965喷油嘴 Injection nozzle Распылитель форсунки 965 60*25*25 0.05 NO.9-1
Remarks: HOWO WD615			Remarks: HOWO WD615 E3		
	Part No. CH part name EN part name RU part name Size: mm Weight: kg NO.	VG1092080401 联轴器 Coupling flange fitting Муфта компрессора двухцилиндровых 2.3 NO.9-2		Part No. CH part name EN part name RU part name Size: mm Weight: kg NO.	VG1560080300 双缸空压机联轴器 Coupling flange fitting Муфта компрессора двухцилиндровых 110*124 2.23 NO.9-2
Remarks: HOWO WD615 D10 EGR			Remarks: HOWO WD615 D10		
	Part No. CH part name EN part name RU part name Size: mm Weight: kg NO.	VG1540080004B 欧3弹性连接片 Flexible connection strap Пластина муфты E вро3 110*110*5 0.16 NO.9-2		Part No. CH part name EN part name RU part name Size: mm Weight: kg NO.	VG1560080277 单缸联轴器 Coupling flange fitting Муфта компрессора 210*124 2.76 NO.9-2
Remarks: HOWO WD615 D10 EGR			Remarks: HOWO WD615 E2		

fuel system		NO.9																			
				KD0245																	
						<table border="1"> <tr><td>Part No.</td><td>VG1560080219</td></tr> <tr><td>CH part name</td><td>弹性连接片</td></tr> <tr><td>EN part name</td><td>Flexible connection strap</td></tr> <tr><td>RU part name</td><td>Пластина муфты</td></tr> <tr><td>Size: mm</td><td>93*52*7.5</td></tr> <tr><td>Weight: kg</td><td>0.15</td></tr> <tr><td>NO.</td><td>NO.9-2</td></tr> </table>		Part No.	VG1560080219	CH part name	弹性连接片	EN part name	Flexible connection strap	RU part name	Пластина муфты	Size: mm	93*52*7.5	Weight: kg	0.15	NO.	NO.9-2
Part No.	VG1560080219																				
CH part name	弹性连接片																				
EN part name	Flexible connection strap																				
RU part name	Пластина муфты																				
Size: mm	93*52*7.5																				
Weight: kg	0.15																				
NO.	NO.9-2																				
Remarks : HOWO WD615 D10				KD0245																	
						<table border="1"> <tr><td>Part No.</td><td>VG1500019005</td></tr> <tr><td>CH part name</td><td>油泵托架</td></tr> <tr><td>EN part name</td><td>Oil pump bracket</td></tr> <tr><td>RU part name</td><td>Стойка насоса</td></tr> <tr><td>Size: mm</td><td></td></tr> <tr><td>Weight: kg</td><td>1.68</td></tr> <tr><td>NO.</td><td>NO.9-3</td></tr> </table>		Part No.	VG1500019005	CH part name	油泵托架	EN part name	Oil pump bracket	RU part name	Стойка насоса	Size: mm		Weight: kg	1.68	NO.	NO.9-3
				Part No.	VG1500019005																
CH part name	油泵托架																				
EN part name	Oil pump bracket																				
RU part name	Стойка насоса																				
Size: mm																					
Weight: kg	1.68																				
NO.	NO.9-3																				
Remarks : HOWO WD615 D10 EGR				KD0248																	
KD0246						<table border="1"> <tr><td>Part No.</td><td>VG1246080043</td></tr> <tr><td>CH part name</td><td>油泵托架</td></tr> <tr><td>EN part name</td><td>Oil pump bracket</td></tr> <tr><td>RU part name</td><td>Стойка насоса</td></tr> <tr><td>Size: mm</td><td></td></tr> <tr><td>Weight: kg</td><td>0.65</td></tr> <tr><td>NO.</td><td>NO.9-3</td></tr> </table>		Part No.	VG1246080043	CH part name	油泵托架	EN part name	Oil pump bracket	RU part name	Стойка насоса	Size: mm		Weight: kg	0.65	NO.	NO.9-3
Part No.	VG1246080043																				
CH part name	油泵托架																				
EN part name	Oil pump bracket																				
RU part name	Стойка насоса																				
Size: mm																					
Weight: kg	0.65																				
NO.	NO.9-3																				
Remarks:HOWO A7 D12						<table border="1"> <tr><td>Part No.</td><td>VG14080074</td></tr> <tr><td>CH part name</td><td>波许喷油泵托架</td></tr> <tr><td>EN part name</td><td>Oil pump bracket</td></tr> <tr><td>RU part name</td><td>Стойка насоса</td></tr> <tr><td>Size: mm</td><td></td></tr> <tr><td>Weight: kg</td><td>1.8</td></tr> <tr><td>NO.</td><td>NO.9-3</td></tr> </table>		Part No.	VG14080074	CH part name	波许喷油泵托架	EN part name	Oil pump bracket	RU part name	Стойка насоса	Size: mm		Weight: kg	1.8	NO.	NO.9-3
Part No.	VG14080074																				
CH part name	波许喷油泵托架																				
EN part name	Oil pump bracket																				
RU part name	Стойка насоса																				
Size: mm																					
Weight: kg	1.8																				
NO.	NO.9-3																				
Remarks: HOWO WD615 E2 VG1500080174				KD0250																	
KD0249						<table border="1"> <tr><td>Part No.</td><td>VG1246080002</td></tr> <tr><td>CH part name</td><td>高压油管</td></tr> <tr><td>EN part name</td><td>Euro III injection pipe</td></tr> <tr><td>RU part name</td><td>Топливная трубка высокого давления</td></tr> <tr><td>Size: mm</td><td>1100*250*120</td></tr> <tr><td>Weight: kg</td><td>2.1</td></tr> <tr><td>NO.</td><td>NO.9-10</td></tr> </table>		Part No.	VG1246080002	CH part name	高压油管	EN part name	Euro III injection pipe	RU part name	Топливная трубка высокого давления	Size: mm	1100*250*120	Weight: kg	2.1	NO.	NO.9-10
Part No.	VG1246080002																				
CH part name	高压油管																				
EN part name	Euro III injection pipe																				
RU part name	Топливная трубка высокого давления																				
Size: mm	1100*250*120																				
Weight: kg	2.1																				
NO.	NO.9-10																				
Remarks: HOWO WD615 E3 EGR D10 VG1096080040						<table border="1"> <tr><td>Part No.</td><td>VG1246080002</td></tr> <tr><td>CH part name</td><td>高压油管</td></tr> <tr><td>EN part name</td><td>Euro III injection pipe</td></tr> <tr><td>RU part name</td><td>Топливная трубка высокого давления</td></tr> <tr><td>Size: mm</td><td></td></tr> <tr><td>Weight: kg</td><td>2.1</td></tr> <tr><td>NO.</td><td>NO.9-10</td></tr> </table>		Part No.	VG1246080002	CH part name	高压油管	EN part name	Euro III injection pipe	RU part name	Топливная трубка высокого давления	Size: mm		Weight: kg	2.1	NO.	NO.9-10
Part No.	VG1246080002																				
CH part name	高压油管																				
EN part name	Euro III injection pipe																				
RU part name	Топливная трубка высокого давления																				
Size: mm																					
Weight: kg	2.1																				
NO.	NO.9-10																				
Remarks: HOWO D12																					









	Part No. CH part name EN part name RU part name Size: mm Weight: kg NO.	VG1560080278 高压油管 Euro II injection pipe Топливная трубка высокого давления 420*250*50 1.15 NO.9-10		Part No. CH part name EN part name RU part name Size: mm Weight: kg NO.	KD0252 VG1246080093 喷油器回油管总成 Oil return pipe assy. Шланг обратки в сборе 0.07 NO.9-15
Remarks: HOWO WD615 E2			Remarks: HOWO D12 E2		
	Part No. CH part name EN part name RU part name Size: mm Weight: kg NO.	VG1096080096 回油管总成 Oil return pipe assy. Шланг обратки в сборе 1800*6 0.075 NO.9-15		Part No. CH part name EN part name RU part name Size: mm Weight: kg NO.	KD0254 VG1500080095 回油管总成 Oil return pipe assy. Шланг обратки в сборе 1800*6 0.071 NO.9-15
Remarks: HOWO D10 EGR			Remarks: HOWO WD615 E2 VG1099089066		
	Part No. CH part name EN part name RU part name Size: mm Weight: kg NO.	VG1560080276 喷油器 Injector Форсунка E вро2 190*20 0.373 NO.9-12		Part No. CH part name EN part name RU part name Size: mm Weight: kg NO.	KD0256 VG1095080085 喷油器 Injector Форсунка E вро2 0.4 NO.9-12
Remarks: HOWO WD615 E2 D10			Remarks: HOWO WD615 EGR 两气门		
	Part No. CH part name EN part name RU part name Size: mm Weight: kg NO.	VG1246080098 油泵机油进油管总成 Oil intake pipe assy. Топливные шланги входного 600*13 0.156 NO.9-35		Part No. CH part name EN part name RU part name Size: mm Weight: kg NO.	KD0258 VG1560070012 进油管总成 Oil intake pipe assy. Топливные шланги входного 600*13 0.17 NO.9-36
Remarks: HOWO D12 VG1557070011 EGR			Remarks: HOWO WD615 E2 D10		

	Part No. CH part name EN part name RU part name Size: mm Weight: kg NO.	VG1560070011 高压油泵进油管总成 Oil intake pipe assy. Топливные шланги входного 420*13 0.13 NO.9-35		Part No. CH part name EN part name RU part name Size: mm Weight: kg NO.	KD0260 VG1246080099 空气管 Air pipe Воздушный труба 0.11 NO.9-11
Remarks: HOWO WD615 E2 D10			Remarks: HOWO D12		
	Part No. CH part name EN part name RU part name Size: mm Weight: kg NO.	VG1560070050 进油管 Oil intake pipe assy. Топливные шланги входного 165 0.1 NO.9-36		Part No. CH part name EN part name RU part name Size: mm Weight: kg NO.	KD0262 AZ1560080018 燃油管 Fuel pipe Топливопровод 530*10 0.058 NO.9-26
Remarks: HOWO WD615 EGR			Remarks :HOWO WD615 E2		
	Part No. CH part name EN part name RU part name Size: mm Weight: kg NO.	AZ1560080017 燃油管 Fuel pipe Топливопровод 420*10 0.055 NO.9-25		Part No. CH part name EN part name RU part name Size: mm Weight: kg NO.	KD0264 VG1092080018 燃油管 Fuel pipe Топливопровод 380*120*20 0.05 NO.9-26
Remarks: HOWO WD615 E2			Remarks: HOWO WD615 EGR		
	Part No. CH part name EN part name RU part name Size: mm Weight: kg NO.	VG1092080017 燃油管 Fuel pipe Топливопровод 420*200*20 0.05 NO.9-25		Part No. CH part name EN part name RU part name Size: mm Weight: kg NO.	KD0266 VG1560080011 燃油滤清器总成 fuel filter assy. Масловой фильтр в сборе 1.71 NO.9-27
Remarks: HOWO WD615 EGR			Remarks: HOWO WD615 D10		

	Part No. CH part name EN part name RU part name Size: mm Weight: kg NO.	VG14080295A 欧II燃油滤清器总成 EuroII fuel filter assy. Масловой фильтр в сборе E вро2 195*225*125 1.56 NO.9-27		Part No. CH part name EN part name RU part name Size: mm Weight: kg NO.	VG14080295A-Z 燃油滤清器座 EuroII fuel filter sea С иденье топливного фильтра 225*125*50 0.45 NO.9-27
Remarks: HOWO WD615 E2			Remarks: HOWO WD615 E2		
	Part No. CH part name EN part name RU part name Size: mm Weight: kg Price: usd	VG14080739A 欧II燃油精滤 EuroII secondary fuel filter Топливный фильтр тонкой очистки 200*90*90 0.205 NO.9-27		Part No. CH part name EN part name RU part name Size: mm Weight: kg NO.	VG14080740A 欧II燃油粗滤 EuroII primary filter Топливный фильтр грубой очистки 200*90*90 0.167 NO.9-27
Remarks: HOWO WD615 E2			Remarks: HOWO WD615 E2		
	Part No. CH part name EN part name RU part name Size: mm Weight: kg NO.	VG1540080110 燃油精滤 Secondary fuel filter Топливный фильтр тонкой очистки 250*96 0.9 NO.9-27		Part No. CH part name EN part name RU part name Size: mm NO. Price: usd	VG1540080211 燃油粗滤 Primary fuel filter Топливный фильтр грубой очистки Евро2 360*120*120 1.1 NO.9-27
Remarks: HOWO WD615 D10 D12			Remarks: HOWO WD615 D10 D12 E3		
	Part No. CH part name EN part name RU part name Size: mm Weight: kg NO.	VG1246080084 燃油粗滤器 fuel filter assy. Масловой фильтр в сборе 1.45 NO.9-27		Part No. CH part name EN part name RU part name Size: mm Weight: kg NO.	VG1246080086 燃油滤清器 fuel filter assy. Масловой фильтр в сборе 1.5 NO.9-27
Remarks: HOWO WD615 D10 D12 E3			Remarks: HOWO WD615 D10 D12 E3		

	Part No. CH part name EN part name RU part name Size: mm Weight: kg NO.	VG1540080132 燃油滤清器总成 fuel filter assy. Масловой фильтр в сборе 1.8 NO.10-3M		Part No. CH part name EN part name RU part name Size: mm Weight: kg NO.	VG1246080075 燃油粗滤 Primary fuel filter Топливный фильтр грубокой очистки 1.35 NO.10-3M
Remarks: HOWO WD615 E3 D10 D12			Remarks: HOWO WD615 E3 D10 D12		
	Part No. CH part name EN part name RU part name Size: mm Weight: kg Price: usd	VG1560080016 燃油粗滤器总成 Primary fuel filter assy. Топливный фильтр грубокой очистки 360*120*120 1.5 NO.10-3M		Part No. CH part name EN part name RU part name Size: mm Weight: kg NO.	VG1540080311 燃油粗滤(PL420) Primary fuel filter Топливный фильтр грубокой очистки 320*110 1.2 NO.10-3M
Remarks: HOWO WD615 E3 D10 D12			Remarks: HOWO WD615 E3 D10 D12		
	Part No. CH part name EN part name RU part name Size: mm Weight: kg NO.	VG1540080211-Z 燃油粗滤器座 Primary fuel filter seat С иденье топливного фильтра грубокой очистки 130*130*120 0.6 NO.10-2M		Part No. CH part name EN part name RU part name Size: mm Weight: kg NO.	VG1540080030 燃油滤清器 fuel filter assy. Масловой фильтр в сборе 1.32 NO.10-1M
Remarks: HOWO WD615 E3 D10 D12			Remarks: HOWO WD615 E3 D10 D12		
	Part No. CH part name EN part name RU part name Size: mm Weight: kg NO.	VG1540080311-ZD 滤清器座 (加热) Filter seat С иденье фильтра 180*180*80 2.25 NO.10		Part No. CH part name EN part name RU part name Size: mm Weight: kg NO.	WG9725550002 燃油粗滤器总成 Fuel preliminary filter assy. Топливный фильтр грубой очистки 195*145*125 1.57 NO.10
Remarks: HOWO E3 D12 D10			Remarks: HOWO		



	Part No. VG1540080110-Z CH part name 燃油精滤器座 EN part name Primary fuel filter seat RU part name С иденье топливного фильтра грубокой очистки Size: mm 130*130*120 Weight: kg 0.6 NO. NO.10-1M		Part No. VG1092080033 CH part name 滤清器座 EN part name Filter seat RU part name С иденье фильтра Size: mm 120*120*80 Weight: kg 0.5 NO. NO.10-1M
Remarks: HOWO		Remarks: HOWO 0311	
	Part No. VG1560080013 CH part name 0012滤清器座 EN part name Filter seat RU part name С иденье фильтра Size: mm 100*100*60 Weight: kg 0.4 NO. NO.10-1M		Part No. VG1092080036 CH part name 滤清器座 EN part name Filter seat RU part name С иденье фильтра Size: mm 170*120*100 Weight: kg 0.8 NO. NO.10-2M
Remarks: HOWO		Remarks: HOWO 0310	
	Part No. VG1540070006 CH part name 机油滤清器座 EN part name Euro III oil filter seat RU part name Головка фильтра масляного E в р03 Size: mm 198*116*98.7 Weight: kg 0.64 NO. NO.10-1M		Part No. VG1540080310 CH part name 燃油精滤芯 EN part name Secondary fuel filter RU part name Топливный фильтр тонкой очистки Size: mm 139*96 Weight: kg 0.55 NO. NO.10-1M
Remarks: HOWO E3		Remarks: HOWO WD615 E3	
	Part No. R61540080101 CH part name 燃料泵 EN part name Euro III injection pump RU part name Топливный насос E в р03 Size: mm 300*280*150 Weight: kg 12.25 NO. NO.10-15		Part No. VG1246080050 CH part name 供油泵总成 EN part name Injection pump RU part name ТНВД Size: mm 300*280*150 Weight: kg 12.25 NO. NO.10-15
Remarks: HOWO D10 WD615 E3		Remarks: HOWO A7 D12 E3	

fuel system **NO.10**

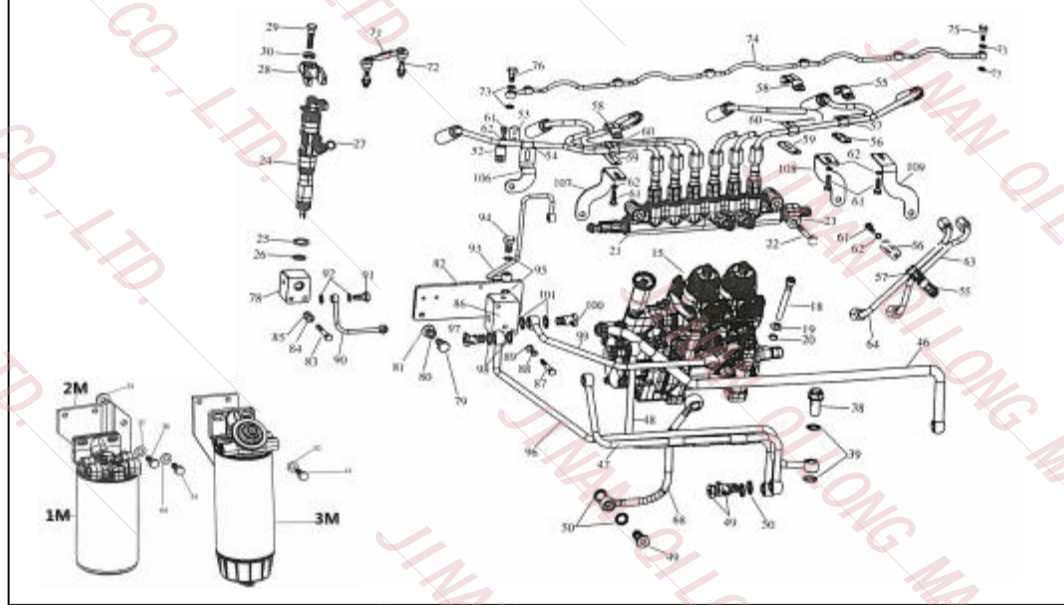

	Part No.	VG1246080036
	CH part name	喷油器
	EN part name	Injector
	RU part name	Форсунка
	Size: mm	200*70*35
	Weight: kg	0.45
	NO.	NO.10-24

Remarks: HOWO D12

	Part No.	R61540080017A
	CH part name	喷油器总成
	EN part name	Euro III injector assy.
	RU part name	Форсунка Е вро3
	Size: mm	220*82*36
	Weight: kg	0.63
	NO.	NO.10-24

Remarks: HOWO WD615 E3 D10

	Part No.	VG1540080065B
	CH part name	共轨喷油器回油短管
	EN part name	Oil return pipe
	RU part name	О братно-топливня трубка
	Size: mm	74*18*18
	Weight: kg	0.03
	Price: usd	NO.10-71

Remarks: HOWO WD615 E3 D10

	Part No.	VG10990890065
	CH part name	喷油器回油短管
	EN part name	Oil return pipe
	RU part name	О братно-топливня трубка
	Size: mm	80*45*18
	Weight: kg	0.04
	NO.	NO.10-71

Remarks: HOWO D12







	Part No.	VG1246080008
	CH part name	喷油器回油管总成
	EN part name	Oil return pipe assy.
	RU part name	Шланг обратки в сборе
	Size: mm	
	Weight: kg	0.07
	NO.	NO.10-74

Remarks: HOWO D12 E3

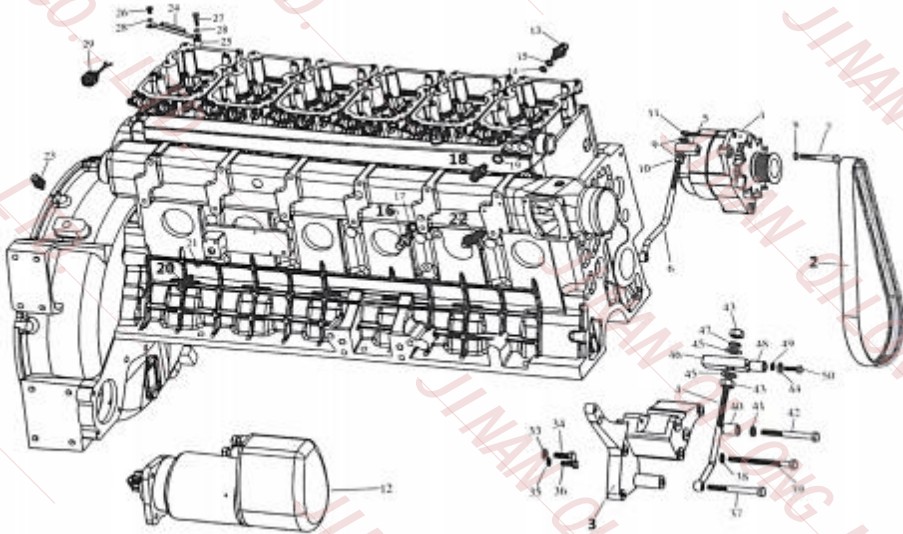
	Part No.	R61540080016
	CH part name	共轨组件
	EN part name	Euro III common rail components
	RU part name	А грегаты Е вро3
	Size: mm	355*98*65
	Weight: kg	3.28
	NO.	NO.10-21

Remarks: HOWO WD615 E3 D10 D12

	Part No. CH part name EN part name RU part name Size: mm Weight: kg NO.	VG1560080012 燃油精滤芯 Secondary fuel filter Топливный фильтр тонкой очистки 205*96 0.78 NO.10-1M		Part No. CH part name EN part name RU part name Size: mm Weight: kg NO.	KD0298 VG1092080034 滤清器水杯 Filter water tank Стакан фильтра 110*110*130 0.2 NO.10-3M
Remarks: HOWO D10 E3			Remarks: HOWO		
	Part No. CH part name EN part name RU part name Size: mm Weight: kg NO.	VG1540089093/94 共轨高压油管组件 Euro III injection pipe components Топливная трубка высокого давления Е вр03 280*80*30 0.5 NO.10-41		Part No. CH part name EN part name RU part name Size: mm Weight: kg NO.	KD0300 VG1540080040 共轨高压油管 Euro III common rail injection pipe Топливная трубка высокого давления Евро3 320*120*100 1.98 NO.10-60
Remarks: HOWO WD615 E3 D10			Remarks: HOWO D12 E3		
	Part No. CH part name EN part name RU part name Size: mm Weight: kg NO.	VG1500098058 1000W两槽发电机 1 KW Alternator Генератор 1000W 175*185*155 6.1 NO.11-1		Part No. CH part name EN part name RU part name Size: mm Weight: kg NO.	KD0302 VG1246090005 发电机28v 80A Alternator Генератор 180*185*155 6 NO.11-1
Remarks: HOWO WD615 E2			Remarks: HOWO D12 E3		
	Part No. CH part name EN part name RU part name Size: mm Weight: kg NO.	VG1500090019 1540W两槽发电机 1540W Alternator(two slots) Генератор 1540W 175*185*155 6.1 NO.11-1		Part No. CH part name EN part name RU part name Size: mm Weight: kg NO.	KD0304 VG1560090012 1540W多楔带发电机 1540W Alternator (multi wedge) Генератор клинчатый 1540W 180*175*147 6.3 NO.11-1
Remarks: HOWO D12 E2 VG1560090010			Remarks: HOWO WD615 E3 D10 VG1560090011		

the part of electrical equipment		NO.11																													
		KD0305																													
			<table border="1"> <tr><td>Part No.</td><td>VG2600090210</td></tr> <tr><td>CH part name</td><td>10齿直驱起动机</td></tr> <tr><td>EN part name</td><td>DD starter (10 teeth)</td></tr> <tr><td>RU part name</td><td>Стартер 10 зубьев</td></tr> <tr><td>Size: mm</td><td>430*180*120</td></tr> <tr><td>Weight: kg</td><td>18.53</td></tr> <tr><td>Price: usd</td><td>NO.11-12</td></tr> </table>	Part No.	VG2600090210	CH part name	10齿直驱起动机	EN part name	DD starter (10 teeth)	RU part name	Стартер 10 зубьев	Size: mm	430*180*120	Weight: kg	18.53	Price: usd	NO.11-12														
Part No.	VG2600090210																														
CH part name	10齿直驱起动机																														
EN part name	DD starter (10 teeth)																														
RU part name	Стартер 10 зубьев																														
Size: mm	430*180*120																														
Weight: kg	18.53																														
Price: usd	NO.11-12																														
		Remarks: HOWO WD615 E2																													
		KD0306																													
			<table border="1"> <tr><td>Part No.</td><td>615000900029</td></tr> <tr><td>CH part name</td><td>11齿直驱起动机</td></tr> <tr><td>EN part name</td><td>DD starter (11 teeth)</td></tr> <tr><td>RU part name</td><td>Стартер 11 зубьев</td></tr> <tr><td>Size: mm</td><td>430*180*120</td></tr> <tr><td>Weight: kg</td><td>18.53</td></tr> <tr><td>NO.</td><td>NO.11-12</td></tr> </table>	Part No.	615000900029	CH part name	11齿直驱起动机	EN part name	DD starter (11 teeth)	RU part name	Стартер 11 зубьев	Size: mm	430*180*120	Weight: kg	18.53	NO.	NO.11-12														
Part No.	615000900029																														
CH part name	11齿直驱起动机																														
EN part name	DD starter (11 teeth)																														
RU part name	Стартер 11 зубьев																														
Size: mm	430*180*120																														
Weight: kg	18.53																														
NO.	NO.11-12																														
		Remarks: HOWO WD615 E2																													
KD0307		KD0308																													
	<table border="1"> <tr><td>Part No.</td><td>VG1560090001</td></tr> <tr><td>CH part name</td><td>ISKL10齿减速起动机</td></tr> <tr><td>EN part name</td><td>ISKL Geared down starter(10 teeth)</td></tr> <tr><td>RU part name</td><td>Стартер замедления 10 зубьев ISKL</td></tr> <tr><td>Size: mm</td><td>450*210*185</td></tr> <tr><td>Weight: kg</td><td>14.5</td></tr> <tr><td>NO.</td><td>NO.11-12</td></tr> </table>	Part No.	VG1560090001	CH part name	ISKL10齿减速起动机	EN part name	ISKL Geared down starter(10 teeth)	RU part name	Стартер замедления 10 зубьев ISKL	Size: mm	450*210*185	Weight: kg	14.5	NO.	NO.11-12		<table border="1"> <tr><td>Part No.</td><td>VG1246090003</td></tr> <tr><td>CH part name</td><td>起动机</td></tr> <tr><td>EN part name</td><td>Geared down starter</td></tr> <tr><td>RU part name</td><td>Стартер замедления 10 зубьев</td></tr> <tr><td>Size: mm</td><td>480*210*185</td></tr> <tr><td>Weight: kg</td><td>14.5</td></tr> <tr><td>NO.</td><td>NO.11-12</td></tr> </table>	Part No.	VG1246090003	CH part name	起动机	EN part name	Geared down starter	RU part name	Стартер замедления 10 зубьев	Size: mm	480*210*185	Weight: kg	14.5	NO.	NO.11-12
Part No.	VG1560090001																														
CH part name	ISKL10齿减速起动机																														
EN part name	ISKL Geared down starter(10 teeth)																														
RU part name	Стартер замедления 10 зубьев ISKL																														
Size: mm	450*210*185																														
Weight: kg	14.5																														
NO.	NO.11-12																														
Part No.	VG1246090003																														
CH part name	起动机																														
EN part name	Geared down starter																														
RU part name	Стартер замедления 10 зубьев																														
Size: mm	480*210*185																														
Weight: kg	14.5																														
NO.	NO.11-12																														
Remarks: HOWO WD615 E3 D10		Remarks: HOWO A7 D12 E3																													
KD0309		KD0310																													
	<table border="1"> <tr><td>Part No.</td><td>VG1560090001-DCF</td></tr> <tr><td>CH part name</td><td>ISKL起动机电磁阀</td></tr> <tr><td>EN part name</td><td>ISKL Starter solenoid valve</td></tr> <tr><td>RU part name</td><td>Клапан стартера ISKL</td></tr> <tr><td>Size: mm</td><td>180*60*60</td></tr> <tr><td>Weight: kg</td><td>1.8</td></tr> <tr><td>NO.</td><td>NO.11-12</td></tr> </table>	Part No.	VG1560090001-DCF	CH part name	ISKL起动机电磁阀	EN part name	ISKL Starter solenoid valve	RU part name	Клапан стартера ISKL	Size: mm	180*60*60	Weight: kg	1.8	NO.	NO.11-12		<table border="1"> <tr><td>Part No.</td><td>VG1560090007</td></tr> <tr><td>CH part name</td><td>起动机</td></tr> <tr><td>EN part name</td><td>Geared down starter</td></tr> <tr><td>RU part name</td><td>Стартер замедления 10 зубьев</td></tr> <tr><td>Size: mm</td><td>450*210*185</td></tr> <tr><td>Weight: kg</td><td>9.5</td></tr> <tr><td>NO.</td><td>NO.11-12</td></tr> </table>	Part No.	VG1560090007	CH part name	起动机	EN part name	Geared down starter	RU part name	Стартер замедления 10 зубьев	Size: mm	450*210*185	Weight: kg	9.5	NO.	NO.11-12
Part No.	VG1560090001-DCF																														
CH part name	ISKL起动机电磁阀																														
EN part name	ISKL Starter solenoid valve																														
RU part name	Клапан стартера ISKL																														
Size: mm	180*60*60																														
Weight: kg	1.8																														
NO.	NO.11-12																														
Part No.	VG1560090007																														
CH part name	起动机																														
EN part name	Geared down starter																														
RU part name	Стартер замедления 10 зубьев																														
Size: mm	450*210*185																														
Weight: kg	9.5																														
NO.	NO.11-12																														
Remarks: HOWO D10		Remarks: HOWO WD615 E3 D10																													

	Part No.	612600090293-DCF		Part No.	612600090293
	CH part name	BOSCH起动机电磁阀		CH part name	BOSCH11齿减速启动
	EN part name	BOSCH Solenoid valve		EN part name	BOSCH Geared down starter (11 teeth)
	RU part name	Клапан стартера BOSCH		RU part name	Стартер замедления 11зубьев BOSCH
	Size: mm	200*60*60		Size: mm	480*210*185
	Weight: kg	1.85		Weight: kg	14.5
	NO.	NO.11-12		NO.	NO.11-12
Remarks: HOWO A7 D12			Remarks: HOWO A7 D12		
	Part No.	VG1092090311		Part No.	VG1500090051
	CH part name	电子式机油压力传感器		CH part name	欧II机油压力传感器
	EN part name	EuroIII oil pressure sensor		EN part name	EuroII oil pressure sensor
	RU part name	Датчик давления масла Е вро3		RU part name	Датчик давления масла
	Size: mm	60*24.3		Size: mm	76*45
	Weight: kg	0.01		Weight: kg	0.13
	NO.	NO.11-13		NO.	NO.11-13
Remarks: HOWO D12 D10 E3 EGR			Remarks: HOWO WD615 E2		
	Part No.	VG14090067		Part No.	VG1500090060
	CH part name	欧II水温传感器		CH part name	机电式压力传感器
	EN part name	EuroII water temperature sensor		EN part name	EuroII oil pressure sensor
	RU part name	Датчик температуры воды		RU part name	Датчик давления масла
	Size: mm	78*19		Size: mm	83*50
	Weight: kg	0.04		Weight: kg	0.07
	NO.	NO.11-18		NO.	NO.11-13
Remarks: HOWO WD615 E2			Remarks: HOWO D10 D12 E2		
	Part No.	R61540090004		Part No.	VG1500090061
	CH part name	水温度传感器		CH part name	水温传感器08款
	EN part name	EuroIII water temperature sensor		EN part name	EuroII water temperature sensor
	RU part name	Датчик температуры воды Е вро3		RU part name	Датчик температуры воды
	Size: mm	56*21.5		Size: mm	38*12
	Weight: kg	0.01		Weight: kg	0.01
	NO.	NO.11-18		NO.	NO.11-18
Remarks: HOWO A7 D12 D10			Remarks: HOWO D12 E2		

	Part No.	R61540090005		Part No.	R61540090007
	CH part name	柴油温度传感器		CH part name	进气压力传感器
	EN part name	EuroIII fuel temperature sensor		EN part name	EuroIII intake air pressure sensor
	RU part name	Датчик температуры дизели Е вро3		RU part name	Датчик давления входного воздуха
	Size: mm	49*21.9		Size: mm	55.5*32.7*32.4
	Weight: kg	0.01		Weight: kg	0.01
	NO.	NO.11-20		Price: usd	NO.11-22
	Remarks: HOWO WD615.93 D10			Remarks: HOWO D10 D12	
	Part No.	R61540090008		Part No.	R61540090003
	CH part name	曲轴转速传感器		CH part name	进气温度传感器
	EN part name	EuroIII crankshaft revolution sensor		EN part name	EuroIII intake air temperature sensor
	RU part name	Датчик скоростей карданного вала Е вро3		RU part name	Датчик температуры входного воздуха
	Size: mm	58.4*33.8*14.2		Size: mm	55.1*24.7
	Weight: kg	0.01		Weight: kg	0.01
	NO.	NO.11-23		Price: usd	NO.11-16
	Remarks: HOWO WD615.93 D10 D12			Remarks: HOWO D10	
	Part No.	VG1540090035		Part No.	VG1557090013
	CH part name	机油压力传感		CH part name	曲轴位置传感器
	EN part name	EuroIII oil pressure sensor		EN part name	Crankshaft position sensor
	RU part name	Датчик давления масла Е вро3		RU part name	Датчик позиции коленчатого вала
	Size: mm	60*24.3		Size: mm	53.2*45.2*23.5
	Weight: kg	0.01		Weight: kg	0.01
	NO.	NO.11-13		NO.	NO.11-23
	Remarks: HOWO WD615.93 E3			Remarks: HOWO WD615 E3 EGR	
	Part No.	VG1500090026		Part No.	VG1500090018
	CH part name	发电机拉紧螺栓		CH part name	发电机拉紧螺栓
	EN part name	Screw		EN part name	Screw
	RU part name	генератор болт		RU part name	генератор болт
	Size: mm			Size: mm	210*10*10
	Weight: kg	0.23		Weight: kg	0.23
	NO.	NO.11-4		NO.	NO.11-6
	Remarks: HOWO WD615 EGR D10			Remarks: HOWO WD615 D10	

	Part No. CH part name EN part name RU part name Size: mm Weight: kg NO.	VG1500090027 拉紧块 натяжной блок Tension block 0.045 NO.11-5		Part No. CH part name EN part name RU part name Size: mm Weight: kg NO.	VG1500090039 发电机拉紧螺栓 Screw генератор болт 150*10*10 0.3 NO.11-6
Remarks: HOWO D10 WD615 E3			Remarks: HOWO WD615 EGR		
	Part No. CH part name EN part name RU part name Size: mm Weight: kg NO.	61500090011 拉紧块 натяжной блок Tension block 0.1 NO.11-5		Part No. CH part name EN part name RU part name Size: mm Weight: kg NO.	VG1246090008 发电机支架 Generator support генератор кронштейн 1.21 NO.11-3
Remarks: HOWO WD615 E2			Remarks: HOWO D12		
	Part No. CH part name EN part name RU part name Size: mm Weight: kg NO.	VG1500090066 发电机多楔带 Multi wedge belt Ремень клинчатый 783*30*5 0.1 NO.11-2		Part No. CH part name EN part name RU part name Size: mm Weight: kg NO.	VG1500130018 发电机支架 Generator support генератор кронштейн 1.1 NO.11-3
Remarks: HOWO D10 6PK-783			Remarks: HOWO D10		
	Part No. CH part name EN part name RU part name Size: mm Weight: kg NO.	VG1540110043 进气管 Intake manifold assy. Коллектор впускной 8 NO.12-1		Part No. CH part name EN part name RU part name Size: mm Weight: kg Price: usd NO.	VG1557110007 进气管 Intake manifold assy. Коллектор впускной 7.7 NO.12-1
Remarks: HOWO D10 WD615 VG1540110036			Remarks: HOWO WD615 EGR VG1557110013		

Inlet and exhaust **NO.12**

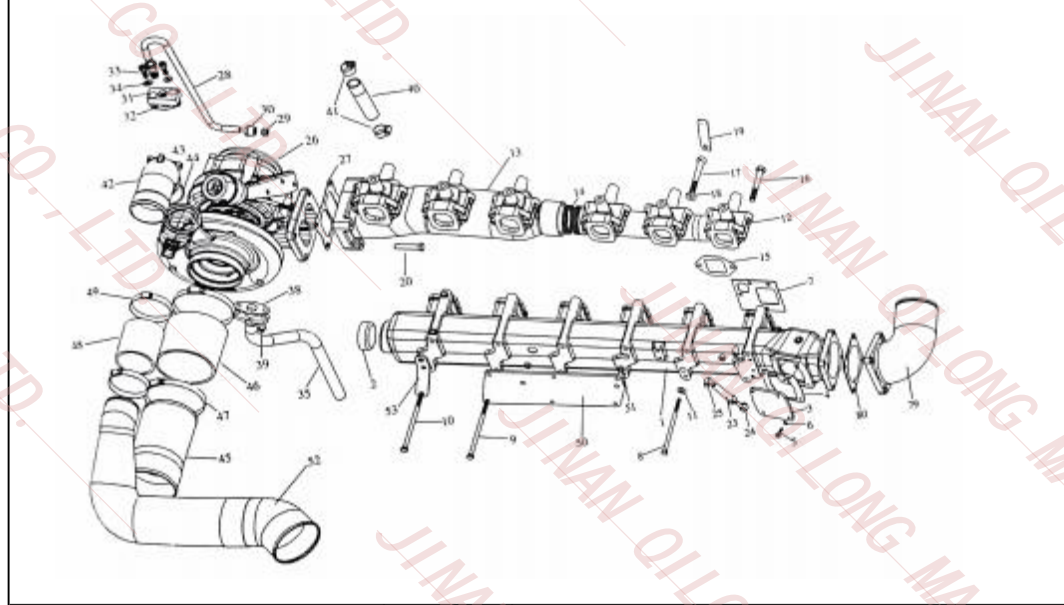

	Part No.	VG2600111290
	CH part name	前排气歧管
	EN part name	Front exhaust manifold
	RU part name	В выпускной коллектор
	Size: mm	455*160*170
	Weight: kg	7.75
	Price: usd	NO.12-12

Remarks: HOWO WD615.92.93.95

	Part No.	VG1557110011
	CH part name	前排气歧管
	EN part name	Front exhaust manifold
	RU part name	В выпускной коллектор
	Size: mm	
	Weight: kg	7.75
	Price: usd	NO.12-12

Remarks: HOWO WD615 EGR

	Part No.	VG1246110002
	CH part name	进气管
	EN part name	Intake manifold assy.
	RU part name	Коллектор впускной
	Size: mm	960*130*210
	Weight: kg	7.7
	Price: usd	NO.12-1

Remarks: HOWO D12 VG1246110001

	Part No.	VG2600110810
	CH part name	进气管
	EN part name	Intake manifold assy.
	RU part name	Коллектор впускной
	Size: mm	1000*230*150
	Weight: kg	8
	Price: usd	NO.12-1

Remarks: HOWO

	Part No.	VG2601100855
	CH part name	后排气歧管
	EN part name	Rear exhaust manifold
	RU part name	В выпускной коллектор
	Size: mm	480*160*215
	Weight: kg	14.11
	Price: usd	NO.12-13

Remarks: HOWO A7 WD615.95









	Part No.	VG1557110012
	CH part name	后排气歧管
	EN part name	Rear exhaust manifold
	RU part name	В выпускной коллектор
	Size: mm	480*160*215
	Weight: kg	14.11
	Price: usd	NO.12-13









Remarks: HOWO WD615 EGR











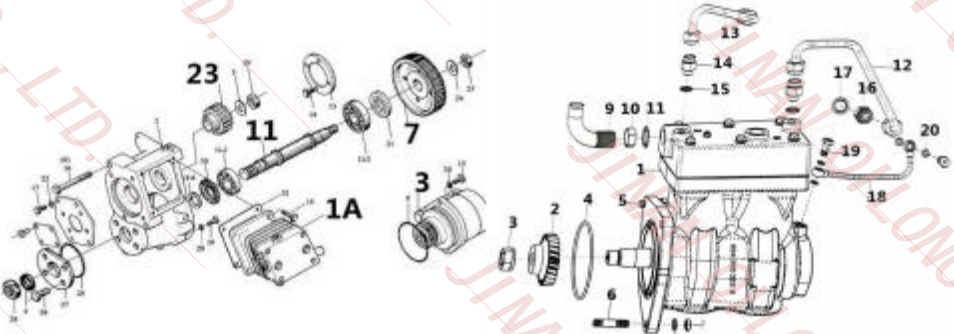

	Part No. CH part name EN part name RU part name Size: mm Weight: kg Price: usd	VG1540110003 前排气歧管 Front exhaust manifold В выпускной коллектор 450*180*150 11 NO.12-12		Part No. CH part name EN part name RU part name Size: mm Weight: kg Price: usd	VG1540110004A 后排气歧管 Rear exhaust manifold В выпускной коллектор 450*160*180 14.11 NO.12-13
Remarks: HOWO WD615.96			Remarks: HOWO WD615.96		
	Part No. CH part name EN part name RU part name Size: mm Weight: kg Price: usd	VG2600111137 前排气歧管 Front exhaust manifold В выпускной коллектор 445*170*160 10 NO.12-12		Part No. CH part name EN part name RU part name Size: mm Weight: kg Price: usd	VG2600111136 后排气歧管 Rear exhaust manifold В выпускной коллектор 480*220*150 14.5 NO.12-13
Remarks: HOWO WD615.93.95.96			Remarks: HOWO WD615.95		
	Part No. CH part name EN part name RU part name Size: mm Weight: kg Price: usd	VG260110162 排气管密封环 Exhaust pipe seal ring Кольцо коллектора 56*50*2 0.01 NO.12-14		Part No. CH part name EN part name RU part name Size: mm Weight: kg NO.	VG1246110027 排气管密封环 Exhaust pipe seal ring Кольцо коллектора 0.01 NO.12-14
Remarks: HOWO WD615 E2			Remarks: HOWO D12		
	Part No. CH part name EN part name RU part name Size: mm Weight: kg NO.	VG1540110005 排气管密封环 Exhaust pipe seal ring Кольцо коллектора 0.01 NO.12-14		Part No. CH part name EN part name RU part name Size: mm Weight: kg NO.	VG1034110051 增压器 Turbocharger Турбокомпрессор 220*240*260 15 NO.12-26
Remarks: HOWO D10			Remarks: HOWO D10		

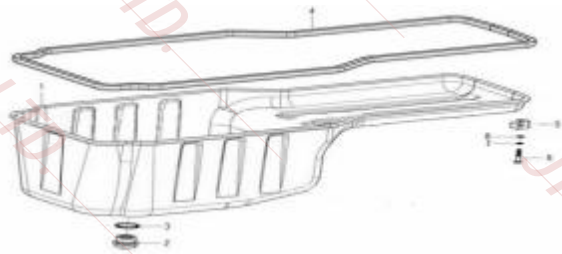
	Part No. CH part name EN part name RU part name Size: mm Weight: kg NO.	VG1246110021 增压器 Turbocharger Турбокомпрессор 290*350*370 15.5 NO.12-26		Part No. CH part name EN part name RU part name Size: mm Weight: kg NO.	VG1540110066 增压器 Turbocharger Турбокомпрессор 220*220*245 19.26 NO.12-26
Remarks: HOWO D12 E2-3			Remarks: HOWO WD615.96		
	Part No. CH part name EN part name RU part name Size: mm Weight: kg NO.	VG1540110006 增压器 EuroIII turbocharger Турбокомпрессор Е в р 3 300*180*180 15.97 NO.12-26		Part No. CH part name EN part name RU part name Size: mm Weight: kg NO.	VG2600118899 废气涡轮增压器 Turbocharger Турбокомпрессор 250*270*225 15.04 NO.12-26
Remarks: HOWO WD615 E3			Remarks: HOWO WD615.87		
	Part No. CH part name EN part name RU part name Size: mm Weight: kg NO.	VG1560118227 废气涡轮增压器 Turbocharger Турбокомпрессор 290*290 16 NO.12-26		Part No. CH part name EN part name RU part name Size: mm Weight: kg NO.	VG1560118228 废气涡轮增压器 Turbocharger Турбокомпрессор 330*270*320 15.7 NO.12-26
Remarks: HOWO WD615 E2			Remarks: HOWO WD615.69		
	Part No. CH part name EN part name RU part name Size: mm Weight: kg NO.	VG2600118898 290马力涡轮增压器 Turbocharger 290 H.P Турбокомпрессор 290 л .с 280*270*270 16.5 NO.12-26		Part No. CH part name EN part name RU part name Size: mm Weight: kg NO.	VG1500119036D 420马力增压器 Turbocharger 420 H.P Турбокомпрессор 420 л .с 300*290*280 17.5 NO.12-26
Remarks: HOWO WD615.87			Remarks: HOWO HX50 WD615		

	Part No. CH part name EN part name RU part name Size: mm Weight: kg NO.	VG1095110143 各种增压器进油管 Turbocharger oil intake pipe Т рубки турбокомпрессора 0.21 NO.12-28		Part No. CH part name EN part name RU part name Size: mm Weight: kg NO.	VG1500119215 增压器卡箍 Turbocharger hoop Хомут турбокомпрессора 110*110*20 0.1 NO.12-49
Remarks: HOWO VG1560070011 VG1560070005 VG1560070002			Remarks: HOWO WD615.62/87		
	Part No. CH part name EN part name RU part name Size: mm Weight: kg NO.	VG1500119216 增压器卡箍 Turbocharger hoop Хомут турбокомпрессора 130*130*20 0.13 NO.12-49		Part No. CH part name EN part name RU part name Size: mm Weight: kg Price: usd	VG1246110028 排气管垫片 Air exhaust pipe gasket П рокладка трубки выпускной 0.016 NO.12-15
Remarks: HOWO WD615.69/47			Remarks: HOWO D12		
	Part No. CH part name EN part name RU part name Size: mm Weight: kg NO.	VG1560110111 排气管垫片 Air exhaust pipe gasket П рокладка трубки выпускной 105*75*1 0.017 NO.12-15		Part No. CH part name EN part name RU part name Size: mm Weight: kg NO.	VG1246110006 进气管垫片 Air inlet gasket П рокладка воздухозаборника 0.014 NO.12-7
Remarks: HOWO WD615 D10			Remarks: HOWO D12		
	Part No. CH part name EN part name RU part name Size: mm Weight: kg NO.	VG1500110024 进气管垫片 Air inlet gasket П рокладка воздухозаборника 106*78*1 0.015 NO.12-7		Part No. CH part name EN part name RU part name Size: mm Weight: kg NO.	VG1540110017 涡轮增压器垫片 Turbocharger gasket П рокладка Турбокомпрессора 135*92*1 0.055 NO.12-27
Remarks: HOWO WD615 D10			Remarks: HOWO WD615 D10 D12		

	Part No. CH part name EN part name RU part name Size: mm Weight: kg NO.	VG1800110045 增压器链接弯管 Link elbow локоть открытый 300*20 0.4 NO.12		Part No. CH part name EN part name RU part name Size: mm Weight: kg NO.	KG9112540015 涡轮增压器垫片 Turbocharger gasket Пкладка Турбокомпрессора 135*41*1 0.053 NO.12
Remarks: HOWO WD615 D10			Remarks: HOWO WD615 D10		
	Part No. CH part name EN part name RU part name Size: mm Weight: kg NO.	VG1560130070 空压机 Air compressor Компрессор 290*215*265 17.16 NO.13-1		Part No. CH part name EN part name RU part name Size: mm Weight: kg NO.	VG1099130010 空压机 Air compressor Компрессор 20.2 NO.13-1
Remarks: HOWO WD615 AZI560130070			Remarks: HOWO D10		
	Part No. CH part name EN part name RU part name Size: mm Weight: kg NO.	VG1246130006 空压机进油管 Air compressor oil intake pipe Маслопровод компрессора 400*30*20 0.2 NO.13-18		Part No. CH part name EN part name RU part name Size: mm Weight: kg NO.	VG1246130008 空压机 Air compressor Компрессор 350*310*180 20.2 NO.13-1
Remarks: HOWO D12 E3			Remarks: HOWO D12		
	Part No. CH part name EN part name RU part name Size: mm Weight: kg NO.	VG1246130003 空压机进水管 Air compressor oil intake pipe Маслопровод компрессора 0.26 NO.13-12		Part No. CH part name EN part name RU part name Size: mm Weight: kg NO.	VG1246130020 空压机出水管总成 Air compressor outlet pipe В ыдыхай из шланга 0.26 NO.13-13
Remarks: HOWO D12 E3			Remarks: HOWO D12 E3		

Air compressor		NO.13															
	KD0373		<table border="1"> <tr><td>Part No.</td><td>VG1092060010</td></tr> <tr><td>CH part name</td><td>空压机进水管</td></tr> <tr><td>EN part name</td><td>Air compressor oil intake pipe</td></tr> <tr><td>RU part name</td><td>Маслопровод комперссора</td></tr> <tr><td>Size: mm</td><td></td></tr> <tr><td>Weight: kg</td><td>0.12</td></tr> <tr><td>NO.</td><td>NO.13-12</td></tr> </table>	Part No.	VG1092060010	CH part name	空压机进水管	EN part name	Air compressor oil intake pipe	RU part name	Маслопровод комперссора	Size: mm		Weight: kg	0.12	NO.	NO.13-12
	Part No.	VG1092060010															
CH part name	空压机进水管																
EN part name	Air compressor oil intake pipe																
RU part name	Маслопровод комперссора																
Size: mm																	
Weight: kg	0.12																
NO.	NO.13-12																
Remarks: HOWO WD615 D10			<table border="1"> <tr><td>Part No.</td><td>VG1560060019</td></tr> <tr><td>CH part name</td><td>空压机出水管</td></tr> <tr><td>EN part name</td><td>Air compressor outlet pipe</td></tr> <tr><td>RU part name</td><td>В ыдыхай из шланга</td></tr> <tr><td>Size: mm</td><td></td></tr> <tr><td>Weight: kg</td><td>0.14</td></tr> <tr><td>NO.</td><td>NO.13-13</td></tr> </table>	Part No.	VG1560060019	CH part name	空压机出水管	EN part name	Air compressor outlet pipe	RU part name	В ыдыхай из шланга	Size: mm		Weight: kg	0.14	NO.	NO.13-13
Part No.	VG1560060019																
CH part name	空压机出水管																
EN part name	Air compressor outlet pipe																
RU part name	В ыдыхай из шланга																
Size: mm																	
Weight: kg	0.14																
NO.	NO.13-13																
KD0375		KD0376															
	Part No.	VG1246130009	Part No.	612600130122													
	CH part name	空压机齿轮	CH part name	空压机传动轴													
	EN part name	Air compressor gear	EN part name	Transmission shaft													
	RU part name	Шестерня компрессора	RU part name	передаточный вал													
	Size: mm	70*70*45	Size: mm														
	Weight: kg	0.8	Weight: kg	0.95													
NO.	NO.13-23	NO.	NO.13-11														
Remarks: HOWO		Remarks: HOWO WD615															
KD0377		KD0378															
	Part No.	VG1560130064	Part No.	VG1560130070XLB													
	CH part name	喷油泵齿轮	CH part name	空压机修理包													
	EN part name	fuel injection pump gear	EN part name	Air compressor repair kit													
	RU part name	топливного насоса лова	RU part name	ремонт пакет													
	Size: mm		Size: mm														
	Weight: kg	2	Weight: kg	0.23													
Price: usd	NO.13-7	Price: usd	NO.13														
Remarks: HOWO WD615 AZ1560130064		Remarks: HOWO WD615															

Oil pan		NO.14		KD0379			
						Part No.	VG2600150108
						CH part name	油底壳磁性螺栓
						EN part name	Oil pan magnetism bolt
						RU part name	П робка масляного поддона
						Size: mm	46*26
						Weight: kg	0.17
						Price: usd	NO.14-2
Remarks: HOWO							
KD0380				KD0381			
		Part No.	VG14150004			Part No.	VG1246130008XLB
		CH part name	油底壳密封圈			CH part name	空压机修理包
		EN part name	Oil pan seal			EN part name	Air compressor repair kit
		RU part name	П рокладка масляного поддона			RU part name	ремонт пакет
		Size: mm	2200*20			Size: mm	
		Weight: kg	0.3			Weight: kg	0.28
		Price: usd	NO.14-4			Price: usd	NO.13
Remarks: HOWO WD615				Remarks: HOWO D10 D12			
KD0382				KD0383			
		Part No.	VG14150046			Part No.	VG2600150106
		CH part name	油底壳托块			CH part name	油底壳磁性螺栓密封圈
		EN part name	Oil pan support block			EN part name	Magnetism bolt seal
		RU part name	маслен поддон			RU part name	Сальник пробки масляного поддона
		Size: mm	29*25*24			Size: mm	50*50*1
		Weight: kg	0.07			Weight: kg	0.01
		Price: usd	NO.14-5			Price: usd	NO.14-3
Remarks: HOWO WD615 D10				Remarks: HOWO WD615 D10			
KD0384				KD0385			
		Part No.	VG1540150002A			Part No.	VG1800150015
		CH part name	油底壳总成			CH part name	油底壳总成
		EN part name	Euro III oil pan			EN part name	Euro II oil pan
		RU part name	Маслянный поддон в сборе Е вро3			RU part name	Маслянный поддон Е вро2
		Size: mm	1120*270*280			Size: mm	1025*250*280
		Weight: kg	10.43			Weight: kg	7.8
		Price: usd	NO.14-1			Price: usd	NO.14-1
Remarks: HOWO WD615 E3 D10				Remarks: HOWO WD615 E2 D10			

	Part No. CH part name EN part name RU part name Size: mm Weight: kg NO.	WG9719190001 空气滤芯总成 Air filter assy. Воздушный фильтр в сборе 700*470*500 13.1 NO.15		Part No. CH part name EN part name RU part name Size: mm Weight: kg NO.	KD0387 VG1246150010 油底壳总成 Euro III oil pan Маслянный поддон в сборе E вро3 7.85 NO.14-1
Remarks: HOWO WG9725190045			Remarks: HOWO D12		
	Part No. CH part name EN part name RU part name Size: mm Weight: kg NO.	KD0388 WG9719190001-1 空滤器滤芯 Air filter element Φ илтроэлемент 485*310 5.04 NO.15		Part No. CH part name EN part name RU part name Size: mm Weight: kg NO.	KD0389 WG9725190155 油式空气滤清器总成 Oil type air filter assy. Влагоотделитель воздушный в сборе 710*470*550 25.5 NO.15
Remarks: HOWO K3046			Remarks: HOWO		
	Part No. CH part name EN part name RU part name Size: mm Weight: kg NO.	KD0390 WG9725190102+0103 09款空气滤芯 Air filter element(2841) Воздушный фильтр 280*280*410 3.5 NO.15		Part No. CH part name EN part name RU part name Size: mm Weight: kg NO.	KD0391 WG9725190150 油式空气滤清器总成 Oil type air filter assy. Влагоотделитель воздушный в сборе 710*470*550 25.5 NO.15
Remarks: HOWO K2841			Remarks: HOWO		
	Part No. CH part name EN part name RU part name Size: mm Weight: kg NO.	KD0392 WG9725190150+001 油式空气滤清器 Oil type air filter Φ илтр воздушный дополнительный 530*400*270 7.55 NO.15		Part No. CH part name EN part name RU part name Size: mm Weight: kg NO.	KD0393 WG9725190200 空气滤清器总成 Air filter assy. Воздушный фильтр в сборе 700*400*400 12.5 NO.15
Remarks: HOWO			Remarks: HOWO		

	Part No.	WG9719190003
	CH part name	双筒进气道总成
	EN part name	Air intake pipe assy.
	RU part name	Воздухозаборник в сборе
	Size: mm	1200*600*250
	Weight: kg	12.5
	NO.	NO.15-10

Remarks: HOWO

	Part No.	WG9725190002
	CH part name	双筒进气道总成
	EN part name	Air intake pipe assy.
	RU part name	Воздухозаборник в сборе
	Size: mm	1200*600*250
	Weight: kg	12.5
	NO.	NO.15-10

Remarks: HOWO WG9725190001

Engine accessory/ AIR FILTER

**NO.15**

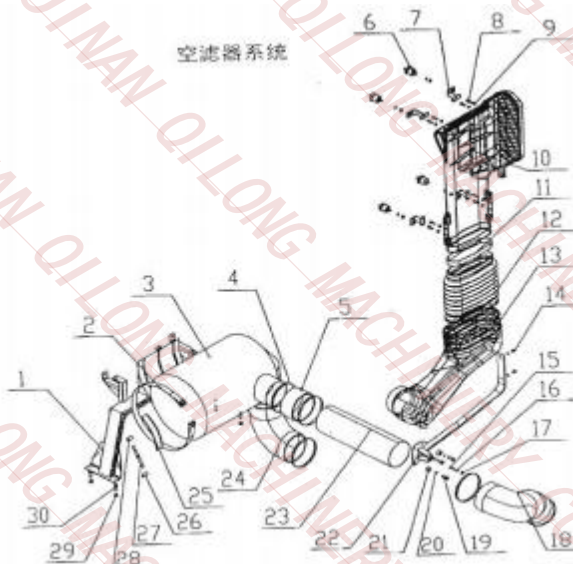

	Part No.	WG9719190014
	CH part name	进气道总成
	EN part name	Air intake pipe assy.
	RU part name	Воздухозаборник Е вро2
	Size: mm	800*370*155
	Weight: kg	2.14
	NO.	NO.15-10

Remarks: HOWO

	Part No.	WG9719190015
	CH part name	进气道波纹管
	EN part name	Air intake bellows
	RU part name	Сифон для воздуховода (гофра резиновая)
	Size: mm	240*180*13.9
	Weight: kg	1.2
	NO.	NO.15-12

Remarks: HOWO WG9725190008

	Part No.	WG9725190905
	CH part name	橡胶软管180
	EN part name	Air intake bellows
	RU part name	Сифон для воздуховода (гофра резиновая)
	Size: mm	180*180*100
	Weight: kg	1.1
	NO.	NO.15-12









Remarks: HOWO

	Part No.	WG9725190144
	CH part name	空气软管
	EN part name	Air hose
	RU part name	воздушный шланг
	Size: mm	
	Weight: kg	0.42
	NO.	NO.15-18

Remarks: HOWO



	Part No. CH part name EN part name RU part name Size: mm Weight: kg NO.	WG9719190009 进气软管 Air filter inlet pipe впускной патрубок 470*65 3.1 NO.15-18		Part No. CH part name EN part name RU part name Size: mm Weight: kg NO.	KD0400 WG9725191350 空滤进气管 Air filter inlet pipe впускной патрубок 0.51 NO.15-13
Remarks: HOWO			Remarks: HOWO		
	Part No. CH part name EN part name RU part name Size: mm Weight: kg NO.	KD0401 WG9725191375 空滤进气管 (后) Air filter inlet pipe впускной патрубок 0.53 NO.15-13		Part No. CH part name EN part name RU part name Size: mm Weight: kg NO.	KD0402 WG9725190042 空气软管 Air hose воздушный шланг 0.83 NO.15-5
Remarks: HOWO			Remarks: HOWO		
	Part No. CH part name EN part name RU part name Size: mm Weight: kg NO.	KD0403 WG9725191431 空滤进气管 Air filter inlet pipe впускной патрубок 0.32 NO.15-13		Part No. CH part name EN part name RU part name Size: mm Weight: kg NO.	KD0404 WG9719530230 铜水箱 Copper radiator Радиатор системы охлаждения (медный) 885*775*100 18.59 NO.16-12
Remarks: HOWO			Remarks: HOWO WD615.47		
	Part No. CH part name EN part name RU part name Size: mm Weight: kg NO.	KD0405 WG9719190008 橡胶管 Rubber tube резиновые трубки 0.3 NO.15-24		Part No. CH part name EN part name RU part name Size: mm Weight: kg NO.	KD0406 WG9719530231 全铝水箱 Aluminum radiator Радиатор системы охлаждения (алюминий) 775*845*145 16 NO.16-12
Remarks: HOWO			Remarks: HOWO WD615.47		

<p>KD0407</p> 	<p>Part No. CH part name EN part name RU part name Size: mm Weight: kg NO.</p>	<p>WG9725530010 铜水箱 Copper radiator Радиатор системы охлаждения (медный) 885*775*100 18.59 NO.16-12</p>	<p>KD0408</p> 	<p>Part No. CH part name EN part name RU part name Size: mm Weight: kg NO.</p>	<p>WG9719530227 冷却水出水软管 Cooling water outtake pipe В выпускной водяной шланг 260*68 0.45 NO.16-46</p>
<p>Remarks:HOWO WD615.62.87.69</p>			<p>Remarks: HOWO WG9725538063</p>		
<p>KD0409</p> 	<p>Part No. CH part name EN part name RU part name Size: mm Weight: kg NO.</p>	<p>WG9725530011 全铝水箱 Aluminum radiator Радиатор системы охлаждения (алюминий) 775*845*145 16 NO.16-12</p>	<p>KD0410</p> 	<p>Part No. CH part name EN part name RU part name Size: mm Weight: kg NO.</p>	<p>WG9719530111 散热器进水管 Radiator intake pipe В пусковой водяной шланг 318*210*58 0.71 NO.16-28</p>
<p>Remarks:HOWO WD615.62.87.69</p>			<p>Remarks: HOWO WG9725538008</p>		
<p>KD0411</p> 	<p>Part No. CH part name EN part name RU part name Size: mm Weight: kg NO.</p>	<p>WG9725530129-1 水箱 Aluminum radiator Радиатор системы охлаждения 975*770 16 NO.16-12</p>	<p>KD0412</p> 	<p>Part No. CH part name EN part name RU part name Size: mm Weight: kg NO.</p>	<p>WG9719530228 胶管 Rubber hose резиновый шланг 75*70*55 0.15 NO.16-36</p>
<p>Remarks: HOWO</p>			<p>Remarks: HOWO 08</p>		
<p>KD0413</p> 	<p>Part No. CH part name EN part name RU part name Size: mm Weight: kg NO.</p>	<p>WG9719530270 水箱 Aluminum radiator Радиатор системы охлаждения 500*450*120 1.2 NO.16-12</p>	<p>KD0414</p> 	<p>Part No. CH part name EN part name RU part name Size: mm Weight: kg NO.</p>	<p>WG9719530212 散热器出水管 Radiator outlet pipe выпускной труба радиатора 500*450*120 1.2 NO.16-45</p>
<p>Remarks: HOWO</p>			<p>Remarks: HOWO</p>		

KD0415		
	Part No.	WG9719530250
	CH part name	增压中冷器
	EN part name	Intercooler
	RU part name	И нтеркулер
	Size: mm	1100*900*210
	Weight: kg	20
	NO.	NO.16-11

Remarks: HOWO WD615 47

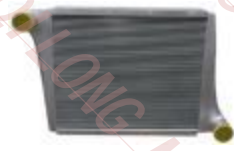
KD0416		
	Part No.	WG9725530020
	CH part name	增压中冷器
	EN part name	Intercooler
	RU part name	И нтеркулер
	Size: mm	1100*900*210
	Weight: kg	20
	NO.	NO.16-11

Remarks: HOWO WD615.62/87/69

KD0417		
	Part No.	WG9725530070
	CH part name	中冷器进气胶管
	EN part name	Air intake hose
	RU part name	Патрубок впускной интеркулера
	Size: mm	200*11
	Weight: kg	0.65
	NO.	NO.16-8

Remarks: HOWO WD615 62/87

KD0418		
	Part No.	WG9719530108
	CH part name	中冷器出气胶管
	EN part name	Air intake hose
	RU part name	Патрубок впускной интеркулера
	Size: mm	165*120
	Weight: kg	0.46
	NO.	NO.16-2-8

Remarks: HOWO WD615 47/69/82 WG9719530307

COOLING SYSTEM **NO.16**

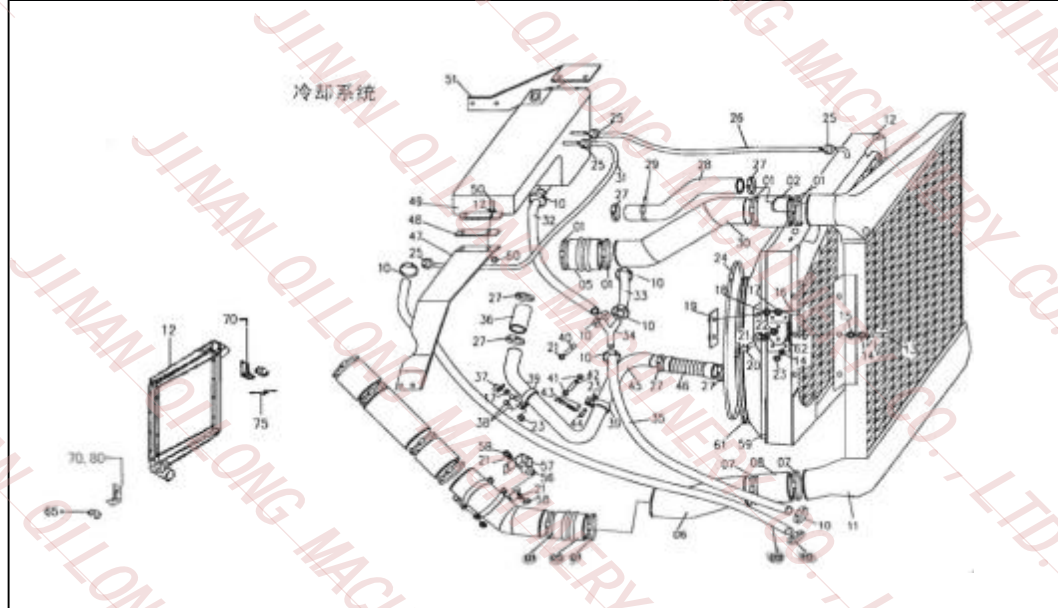

KD0419		
	Part No.	WG9719530122
	CH part name	中冷器出气管
	EN part name	Air intake hose
	RU part name	Патрубок впускной интеркулера
	Size: mm	
	Weight: kg	1.95
	NO.	NO.16-30

Remarks: HOWO WD615 47/69/82

KD0420		
	Part No.	WG9114530139
	CH part name	膨胀箱胶管
	EN part name	Expansion box hose
	RU part name	расширительный бак шланг
	Size: mm	8*1700
	Weight: kg	0.21
	NO.	NO.16-31

Remarks: HOWO